

# RH850/F1x StarterKit V3

User Manual: Hardware

RENESAS MCU  
RH850 F1x Series

Y-ASK-RH850F1L-V3

Y-ASK-RH850F1K-V3

Y-ASK-RH850F1H-V3

Y-ASK-RH850F1KM-S4-V3

Y-ASK-RH850F1KH-D8-V3

All information contained in these materials, including products and product specifications, represents information on the product at the time of publication and is subject to change by Renesas Electronics Corp. without notice. Please review the latest information published by Renesas Electronics Corp. through various means, including the Renesas Electronics Corp. website (<http://www.renesas.com>).

For updates of the StarterKit software and documentation please check:

<http://www.renesas.com/ASK-RH850F1X>

## Notice

1. All information included in this document is current as of the date this document is issued. Such information, however, is subject to change without any prior notice. Before purchasing or using any Renesas Electronics products listed herein, please confirm the latest product information with a Renesas Electronics sales office. Also, please pay regular and careful attention to additional and different information to be disclosed by Renesas Electronics such as that disclosed through our website.
2. Renesas Electronics does not assume any liability for infringement of patents, copyrights, or other intellectual property rights of third parties by or arising from the use of Renesas Electronics products or technical information described in this document. No license, express, implied or otherwise, is granted hereby under any patents, copyrights or other intellectual property rights of Renesas Electronics or others.
3. You should not alter, modify, copy, or otherwise misappropriate any Renesas Electronics product, whether in whole or in part.
4. Descriptions of circuits, software and other related information in this document are provided only to illustrate the operation of semiconductor products and application examples. You are fully responsible for the incorporation of these circuits, software, and information in the design of your equipment. Renesas Electronics assumes no responsibility for any losses incurred by you or third parties arising from the use of these circuits, software, or information.
5. When exporting the products or technology described in this document, you should comply with the applicable export control laws and regulations and follow the procedures required by such laws and regulations. You should not use Renesas Electronics products or the technology described in this document for any purpose relating to military applications or use by the military, including but not limited to the development of weapons of mass destruction. Renesas Electronics products and technology may not be used for or incorporated into any products or systems whose manufacture, use, or sale is prohibited under any applicable domestic or foreign laws or regulations.
6. Renesas Electronics has used reasonable care in preparing the information included in this document, but Renesas Electronics does not warrant that such information is error free. Renesas Electronics assumes no liability whatsoever for any damages incurred by you resulting from errors in or omissions from the information included herein.
7. Renesas Electronics products are classified according to the following three quality grades: "Standard", "High Quality", and "Specific". The recommended applications for each Renesas Electronics product depends on the product's quality grade, as indicated below. You must check the quality grade of each Renesas Electronics product before using it in a particular application. You may not use any Renesas Electronics product for any application categorized as "Specific" without the prior written consent of Renesas Electronics. Further, you may not use any Renesas Electronics product for any application for which it is not intended without the prior written consent of Renesas Electronics. Renesas Electronics shall not be in any way liable for any damages or losses incurred by you or third parties arising from the use of any Renesas Electronics product for an application categorized as "Specific" or for which the product is not intended where you have failed to obtain the prior written consent of Renesas Electronics. The quality grade of each Renesas Electronics product is "Standard" unless otherwise expressly specified in a Renesas Electronics data sheets or data books, etc.
 

"Standard": Computers; office equipment; communications equipment; test and measurement equipment; audio and visual equipment; home electronic appliances; machine tools; personal electronic equipment; and industrial robots.

"High Quality": Transportation equipment (automobiles, trains, ships, etc.); traffic control systems; anti-disaster systems; anti-crime systems; safety equipment; and medical equipment not specifically designed for life support.

"Specific": Aircraft; aerospace equipment; submersible repeaters; nuclear reactor control systems; medical equipment or systems for life support (e.g. artificial life support devices or systems), surgical implantations, or healthcare intervention (e.g. excision, etc.), and any other applications or purposes that pose a direct threat to human life.
8. You should use the Renesas Electronics products described in this document within the range specified by Renesas Electronics, especially with respect to the maximum rating, operating supply voltage range, movement power voltage range, heat radiation characteristics, installation and other product characteristics. Renesas Electronics shall have no liability for malfunctions or damages arising out of the use of Renesas Electronics products beyond such specified ranges.
9. Although Renesas Electronics endeavors to improve the quality and reliability of its products, semiconductor products have specific characteristics such as the occurrence of failure at a certain rate and malfunctions under certain use conditions. Further, Renesas Electronics products are not subject to radiation resistance design. Please be sure to implement safety measures to guard them against the possibility of physical injury, and injury or damage caused by fire in the event of the failure of a Renesas Electronics product, such as safety design for hardware and software including but not limited to redundancy, fire control and malfunction prevention, appropriate treatment for aging degradation or any other appropriate measures. Because the evaluation of microcomputer software alone is very difficult, please evaluate the safety of the final products or system manufactured by you.
10. Please contact a Renesas Electronics sales office for details as to environmental matters such as the environmental compatibility of each Renesas Electronics product. Please use Renesas Electronics products in compliance with all applicable laws and regulations that regulate the inclusion or use of controlled substances, including without limitation, the EU RoHS Directive. Renesas Electronics assumes no liability for damages or losses occurring as a result of your noncompliance with applicable laws and regulations.
11. This document may not be reproduced or duplicated, in any form, in whole or in part, without prior written consent of Renesas Electronics.
12. Please contact a Renesas Electronics sales office if you have any questions regarding the information contained in this document or Renesas Electronics products, or if you have any other inquiries.

(Note 1) "Renesas Electronics" as used in this document means Renesas Electronics Corporation and also includes its majority-owned subsidiaries.

(Note 2) "Renesas Electronics product(s)" means any product developed or manufactured by or for Renesas Electronics.

## Table of Contents

<b>1.</b>	<b>Introduction</b> .....	<b>4</b>
<b>2.</b>	<b>Cautions</b> .....	<b>5</b>
<b>3.</b>	<b>Quick Start Information</b> .....	<b>6</b>
<b>3.1</b>	<b>Connector and jumper overview</b> .....	<b>6</b>
<b>3.2</b>	<b>Board Overview RH850/F1L Version [Y-ASK-RH850F1L-V3]</b> .....	<b>10</b>
<b>3.3</b>	<b>Board Overview RH850/F1K Version [Y-ASK-RH850F1K-V3]</b> .....	<b>11</b>
<b>3.4</b>	<b>Board Overview RH850/F1H Version [Y-ASK-RH850F1H-V3]</b> .....	<b>12</b>
<b>3.5</b>	<b>Board Overview RH850/F1KM-S4 Version [Y-ASK-RH850F1KM-S4-V3]</b> .....	<b>13</b>
<b>3.6</b>	<b>Board Overview RH850/F1KH-D8 Version [Y-ASK-RH850F1KH-D8-V3]</b> .....	<b>14</b>
<b>4.</b>	<b>StarterKit Hardware</b> .....	<b>15</b>
<b>4.1</b>	<b>StarterKit functions</b> .....	<b>15</b>
<b>4.2</b>	<b>Functional Areas</b> .....	<b>16</b>
4.2.1	Power Supply .....	17
4.2.2	Microcontroller Area and Port Pin Interfaces .....	19
4.2.3	LEDs .....	20
4.2.4	Digital inputs for Low Power Sampler (LPS).....	22
4.2.5	Pushbutton Switches.....	22
4.2.6	Analog Input - Potentiometer .....	23
4.2.7	Rotary Encoder with Pushbutton Switch .....	23
4.2.8	Serial Communication Interfaces .....	24
4.2.9	On-chip Debug and Flash Programming Connector .....	28
4.2.10	OLED Board (optional).....	28
<b>5.</b>	<b>Development tools</b> .....	<b>29</b>
<b>5.1</b>	<b>E1 On-Chip Debug Emulator [R0E000010KCE00]</b> .....	<b>29</b>
<b>5.2</b>	<b>Development Software</b> .....	<b>29</b>
<b>6.</b>	<b>RH850/F1x StarterKit Example Software</b> .....	<b>30</b>
<b>6.1</b>	<b>StartUp Test</b> .....	<b>31</b>
<b>6.2</b>	<b>Mode 1</b> .....	<b>31</b>
<b>6.3</b>	<b>Mode 2</b> .....	<b>32</b>
<b>6.4</b>	<b>StandBy</b> .....	<b>33</b>
<b>6.5</b>	<b>Webserver Application</b> .....	<b>33</b>
<b>7.</b>	<b>Component Placement and Schematics</b> .....	<b>34</b>
<b>7.1</b>	<b>Component placement</b> .....	<b>34</b>
7.1.1	Release Version EEAS-0401-002-01 .....	34
7.1.2	Release Version EEAS-0401-003-01 .....	35
<b>7.2</b>	<b>Schematics</b> .....	<b>36</b>
7.2.1	Y-ASK-RH850F1L-V3 and Y-ASK-RH850F1K-V3 Schematics.....	36
7.2.2	Y-ASK-RH850F1H-V3 Schematics .....	38
7.2.3	Y-ASK-RH850F1KM-S4-V3 Schematics.....	39
7.2.4	Y-ASK-RH850F1KH-D8-V3 Schematics.....	40
<b>8.</b>	<b>Revision History</b> .....	<b>41</b>

## 1. Introduction

The 'RH850/F1x StarterKit' serves as a simple and easy to use platform for evaluating the features and performance of Renesas Electronics' 32-bit RH850/F1x microcontrollers.

Features:

- Connections for on-chip debugging and flash memory programming
- Access to all microcontroller I/O pins
- User interaction through potentiometer, rotary switch, buttons and LEDs
- Serial interface connections for
  - 1x RS232
  - 1x LIN
  - 2x CAN-FD (RH850/F1L version does only support High Speed CAN)
  - 1x FlexRay (RH850/F1H, F1KM-S4 and F1KH-D8 version only)
  - 1x Ethernet 100Base-T (RH850/F1H, F1KM-S4 and F1KH-D8 version only)
- Power supply by RENESAS E1 On-Chip debugger or externally (12V DC input)
- Support of different RH850/F1x family members
  - RH850/F1L
  - RH850/F1K
  - RH850/F1H
  - RH850/F1KM-S4
  - RH850/F1KH-D8

This document will describe the functionality provided by the StarterKit and guide the user through its operation. For details regarding the operation of the microcontroller refer to the RH850/F1x User Manuals.

## 2. Cautions

1. Do not look into the LED beam!

Special care must be taken with the high power LEDs



2. When power supply of E1 On-Chip debugger is used please note that the maximum current provided by the debugger is limited to 200mA. Thus an external power supply is required in case all functions on the StarterKit are used to full extend.

### 3. Quick Start Information

#### 3.1 Connector and jumper overview

J1				J2			
Pin	Function		Pin	Pin	Function		Pin
1	P11_1	P11_2	2	1	P12_5	P11_0	2
3	P11_3	P11_4	4	3	P12_3	P12_4	4
5	P11_5	P11_6	6	5	P12_1	P12_2	6
7	P11_7	P11_8	8	7	P10_15	P12_0	8
9	P11_9	P11_10	10	9	P10_13	P10_14	10
11	P11_11	P11_12	12	11	P10_11	P10_12	12
13	P11_13 (not for F1Kx)	P11_14 (not for F1Kx)	14	13	P10_9	P10_10	14
15	P11_15	P0_0	16	15	P10_7	P10_8	16
17	P0_1	P0_2	18	17	P10_5	P10_6	18
19	P0_3	P0_4	20	19	P10_3	P10_4	20
21	P0_5	P0_6	22	21	P10_1	P10_2	22
23	P0_7	P0_8	24	23	P18_7	P10_0	24
25	P0_9	P0_10	26	25	P18_5	P18_6	26
27	P0_11	P0_12	28	27	P18_3	P18_4	28
29	P0_13	P0_14	30	29	P18_1	P18_2	30
31	JP0_6	JP0_5	32	31	AP1_15	P18_0	32
33	JP0_4	JP0_3	34	33	AP1_13	AP1_14	34
35	JP0_2	JP0_1	36	35	AP1_11	AP1_12	36
37	JP0_0	P1_15	38	37	AP1_9	AP1_10	38
39	GND	VCC5	40	39	GND	VCC5	40

**Table 1. J1 – J2 – Signal Assignment**

J3				J4			
Pin	Function		Pin	Pin	Function		Pin
1	P1_14	P1_13	2	1	AP1_0	AP1_1	2
3	P1_12	P1_11	4	3	AP1_2	AP1_3	4
5	P1_10	P1_9	6	5	AP1_4	AP1_5	6
7	P1_8	P1_7 (not for F1Kx)	8	7	AP1_6	AP1_7	8
9	P1_6 (not for F1Kx)	P1_5	10	9	P20_5	AP1_8	10
11	P1_4	P1_3	12	11	P20_3	P20_4	12
13	P1_2	P1_1	14	13	P20_1	P20_2	14
15	P1_0	IP0_0	16	15	P9_6 (F1L/F1K only)	P20_0	16
17	FLMD0	RESET	18	17	P9_4	P9_5 (F1L/F1K only)	18
19	P2_0	P2_1	20	19	P9_2	P9_3	20
21	P2_2	P2_3	22	21	P9_0	P9_1	22
23	P2_4	P2_5	24	23	AP0_0	AP0_1	24
25	P2_6	P8_0	26	25	AP0_2	AP0_3	26
27	P8_1	P8_2	28	27	AP0_4	AP0_5	28
29	P8_3	P8_4	30	29	AP0_6	AP0_7	30
31	P8_5	P8_6	32	31	AP0_8	AP0_9	32
33	P8_7	P8_8	34	33	AP0_10	AP0_11	34
35	P8_9	P8_10	36	35	AP0_12	AP0_13	36
37	P8_11	P8_12	38	37	AP0_14	AP0_15	38
39	GND	VCC5	40	39	GND	VCC5	40

**Table 2. J3 – J4 – Signal Assignment**

Jumper	Description	Setting	Note
J5	MCU power distribution (Note: setting 7-8 for further expansion)	1 – 2	REG0VCC supply
		3 – 4	EVCC/AVREF supply
		5 – 6	BVCC supply
		7 – 8	REG1VCC
J6	CAN0/1 transceiver NSIL enable to MCU connector	1 – 2	CAN0NSIL ↔ P1_1
		3 – 4	CAN0NSIL ↔ P2_6
J7	CAN0/1 transceiver TX/RX to MCU connector	1 – 2	CAN0TX ↔ P1_3
		3 – 4	CAN0RX ↔ P1_2
		5 – 6	CAN1TX ↔ P1_13
		7 – 8	CAN1RX ↔ P1_12
J8	FLEXRAY transceiver TX/RX to MCU connector (RH850/F1H and RH850/F1KM-S4 only)	1 – 2	FR_RXD ↔ P10_14
		3 – 4	FR_TXEZ ↔ P10_11
		5 – 6	FR_TXD ↔ P11_1
J9	Digital LPS input to MCU connector	1 – 2	DIN ↔ P8_1
		3 – 4	SELDP0 ↔ P0_4
		5 – 6	SELDP1 ↔ P0_5
		7 – 8	SELDP2 ↔ P0_6
		9 – 10	DPO ↔ P0_0
J11	VBAT selector	1 – 2	VBAT ↔ external 12V
		2 – 3	VBAT ↔ 5V
J12	Blue LED Circle to MCU connector	1 – 2	SPI driver LE ↔ P1_14
		3 – 4	SPI driver OE# ↔ P1_15
		5 – 6	SPI driver CLK ↔ P0_14
		7 – 8	SPI driver SI ↔ P0_13
		9 – 10	SPI driver SO ↔ P0_12
J13	RGB LED Connector	1 – 2	R_PWM feedback ↔ AP0_1
		3 – 4	G_PWM feedback ↔ AP0_3
		5 – 6	B_PWM feedback ↔ AP0_2
J14	Potentiometer to MCU Connector	1 – 2	POT1 ↔ AP0_0
		3 – 4	AP0 ↔ P0_1



J15	Indication LED to MCU Connector	<b>1 – 2</b>	LED1 ↔ P0_11
		<b>3 – 4</b>	LED2 ↔ P8_5
J16	Interrupt Button to MCU connector	<b>1 – 2</b>	Button ↔ P0_9
J17	LIN Transceiver to MCU connector	<b>1 – 2</b>	LIN RX ↔ P0_7
		<b>3 – 4</b>	LIN TX ↔ P0_8
J18	RS232 Transceiver to MCU connector	<b>1 – 2</b>	R232 TX ↔ P0_2
		<b>3 – 4</b>	R232 RX ↔ P0_3
J19	Encoder Potentiometer to MCU connector	<b>1 – 2</b>	Encoder input 0 ↔ P10_9
		<b>3 – 4</b>	Encoder input 1 ↔ P10_10
		<b>5 – 6</b>	Encoder button ↔ P1_4
J20	PWM output to RGB LED connector	<b>1 – 2</b>	R_PWM signal ↔ P20_0
		<b>3 – 4</b>	G_PWM signal ↔ P20_1
		<b>5 – 6</b>	B_PWM signal ↔ P20_2

**Table 3. Jumper / Connector Settings Overview (for Release Version EEAS-0401-003-01)**

**Note:** Default jumper setting (Power Supply by E1 Debugger) is indicated by **bold font**.

### 3.2 Board Overview RH850/F1L Version [Y-ASK-RH850F1L-V3]

The RH850/F1L Version of the V3 StarterKit is available in two versions:

- RH850-F1X-Starter-Kit-F1L V3 Release Version EEAS-0401-002-01
- RH850-F1X-Starter-Kit-F1L V3 Release Version EEAS-0401-003-01

The difference is only related to the power supply circuit (see detailed description in chapter '4.2.1 Power Supply' and '7.2.1 Y-ASK-RH850F1L-V3 and Y-ASK-RH850F1K-V3 Schematics'). It has no influence on functionalities related to the microcontroller.

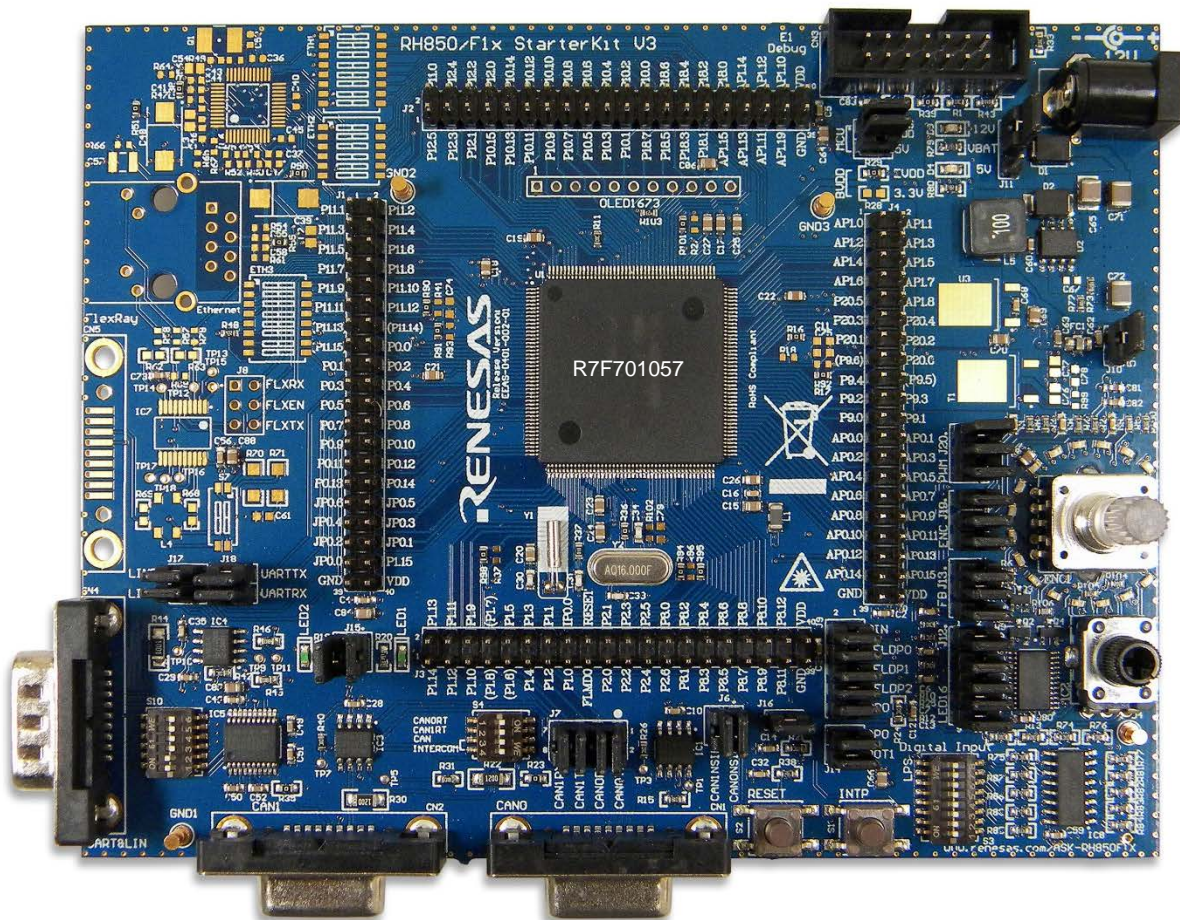

Figure 1. StarterKit V3 top view RH850/F1L (Release Version EEAS-0401-002-01)

### 3.3 Board Overview RH850/F1K Version [Y-ASK-RH850F1K-V3]

The RH850/F1K Version of the V3 Starterkit is available in two versions:

- RH850-F1X-Starter-Kit-F1K V3 Release Version EEAS-0401-002-01
- RH850-F1X-Starter-Kit-F1K V3 Release Version EEAS-0401-003-01

The difference is only related to the power supply circuit (see detailed description in chapters '4.2.1 Power Supply'). It has no influence on functionalities related to the microcontroller.

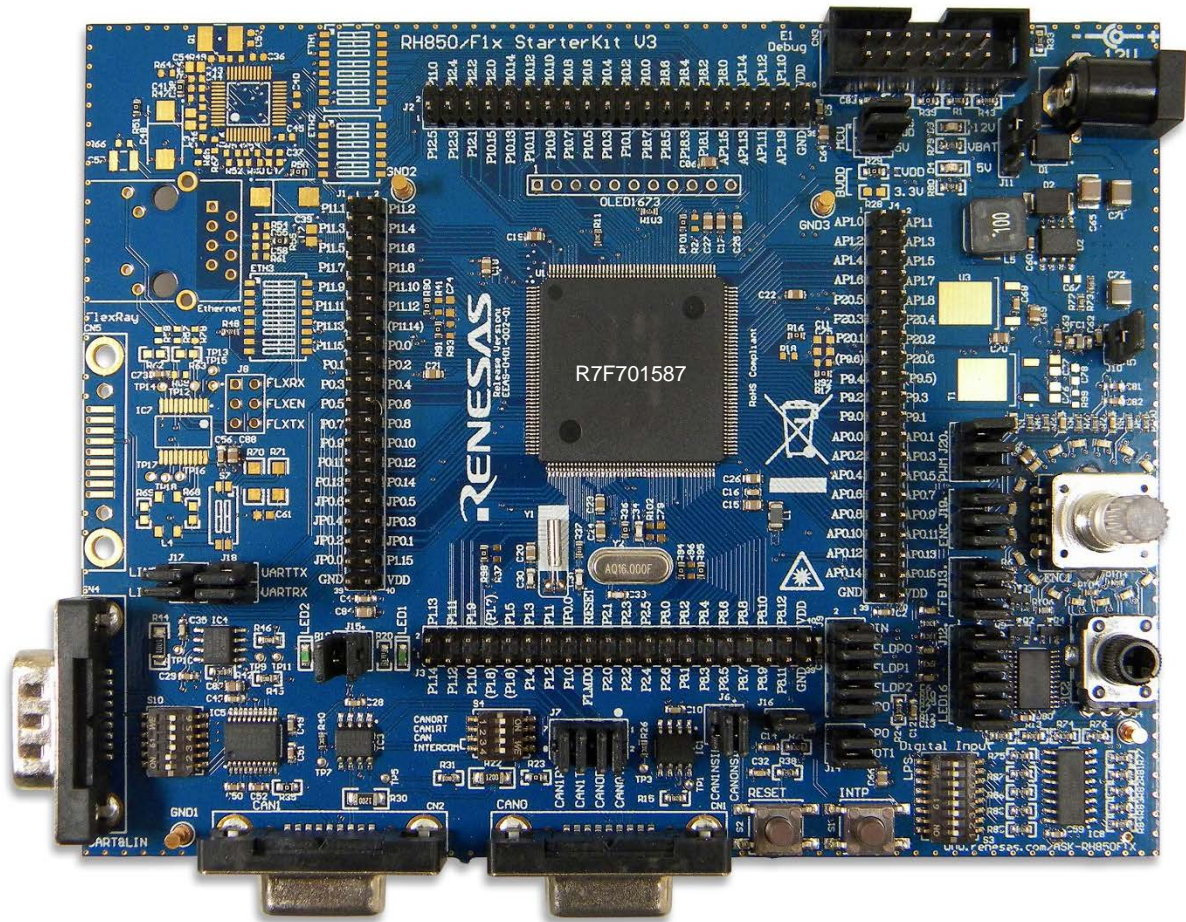

Figure 2. StarterKit V3 top view RH850/F1K (Release Version EEAS-0401-002-01)

### 3.4 Board Overview RH850/F1H Version [Y-ASK-RH850F1H-V3]

The RH850/F1H Version of the V3 Starterkit is shown in the figure below.

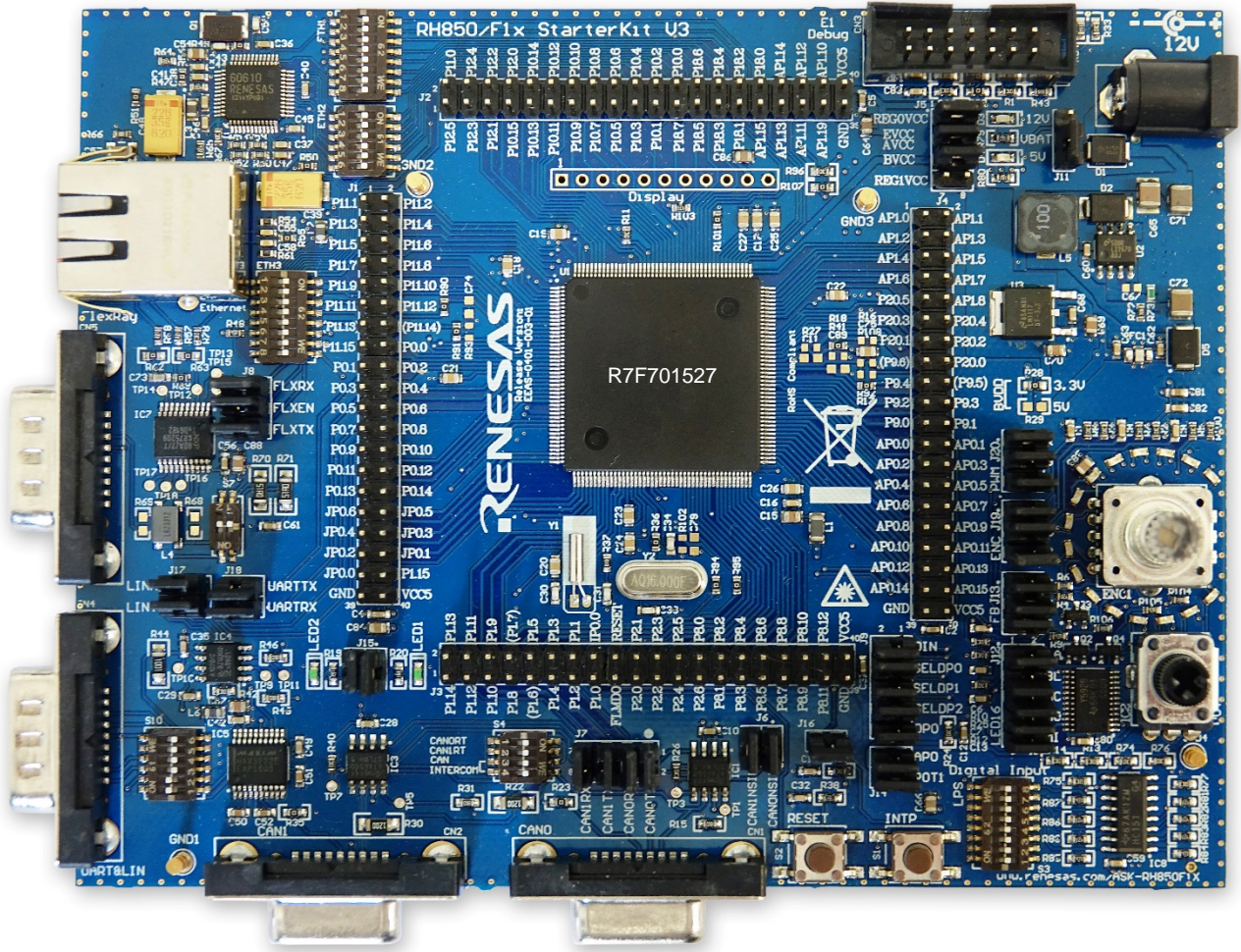

Figure 3. StarterKit V3 top view RH850/F1H

### 3.5 Board Overview RH850/F1KM-S4 Version [Y-ASK-RH850F1KM-S4-V3]

The RH850/F1KM-S4 Version of the V3 StarterKit is shown in the figure below.

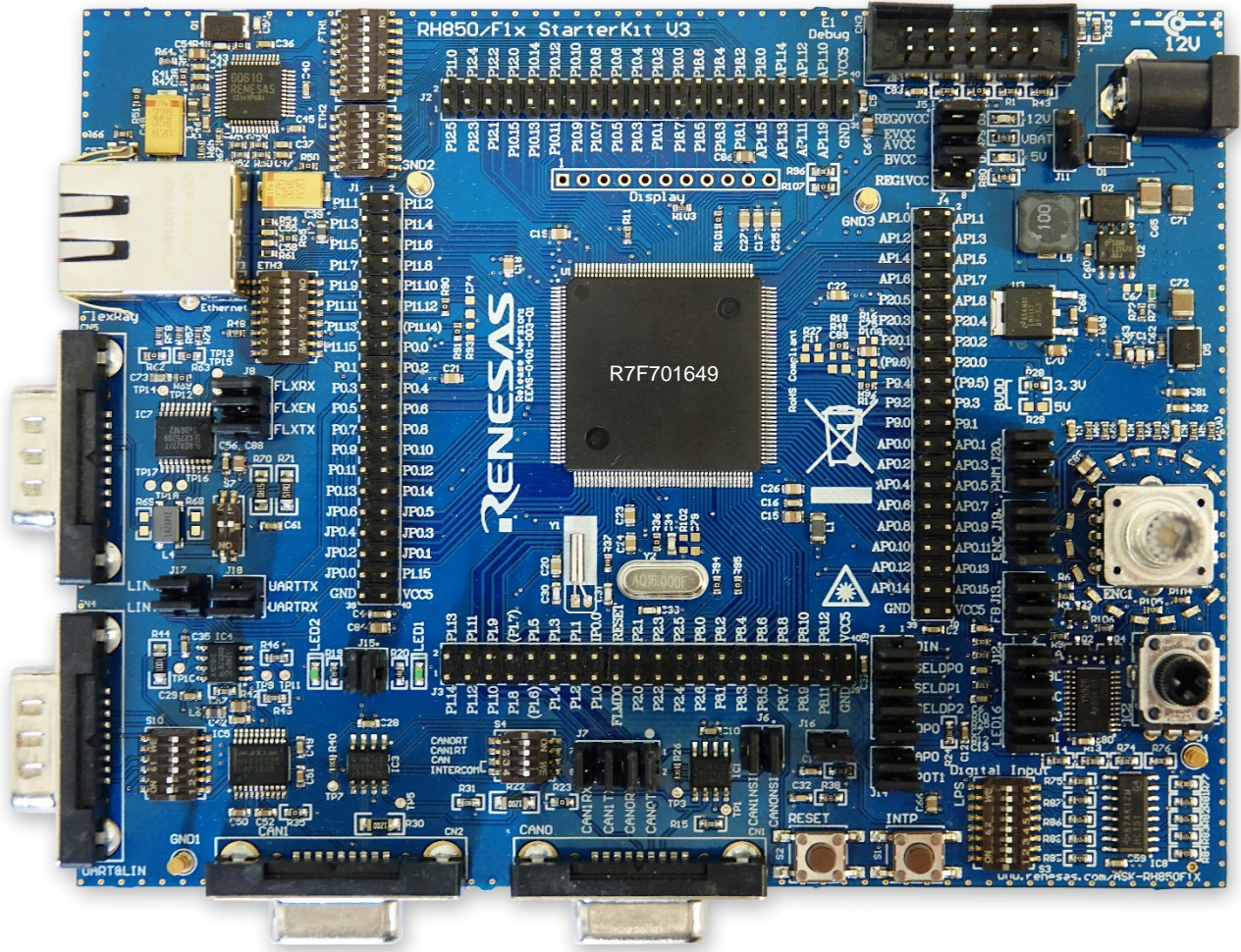

Figure 4. StarterKit V3 top view RH850/F1KM-S4

### 3.6 Board Overview RH850/F1KH-D8 Version [Y-ASK-RH850F1KH-D8-V3]

The RH850/F1KH-D8 Version of the V3 StarterKit is shown in the figure below.

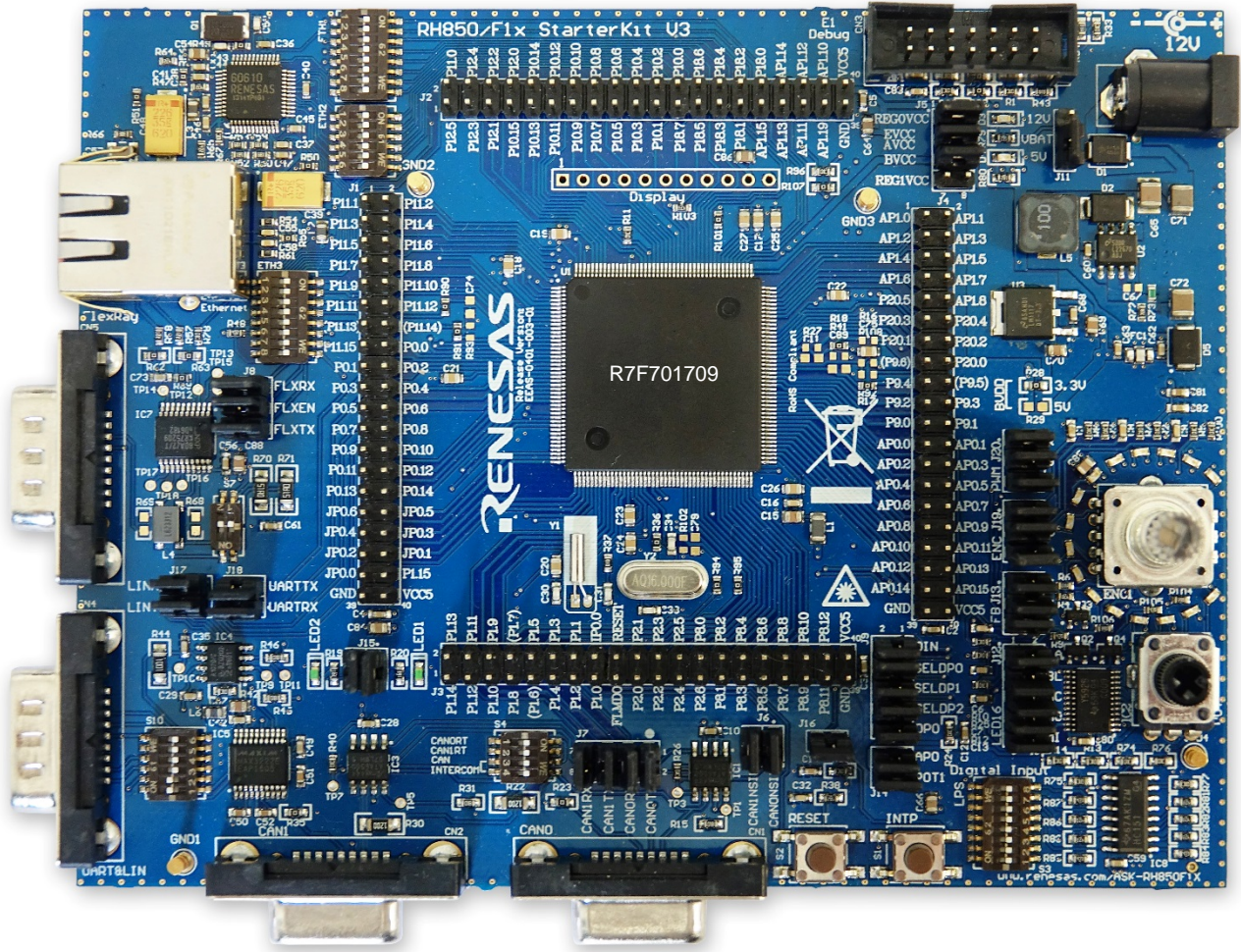

Figure 5. StarterKit V3 top view RH850/F1KH-D8

## 4. StarterKit Hardware

### 4.1 StarterKit functions

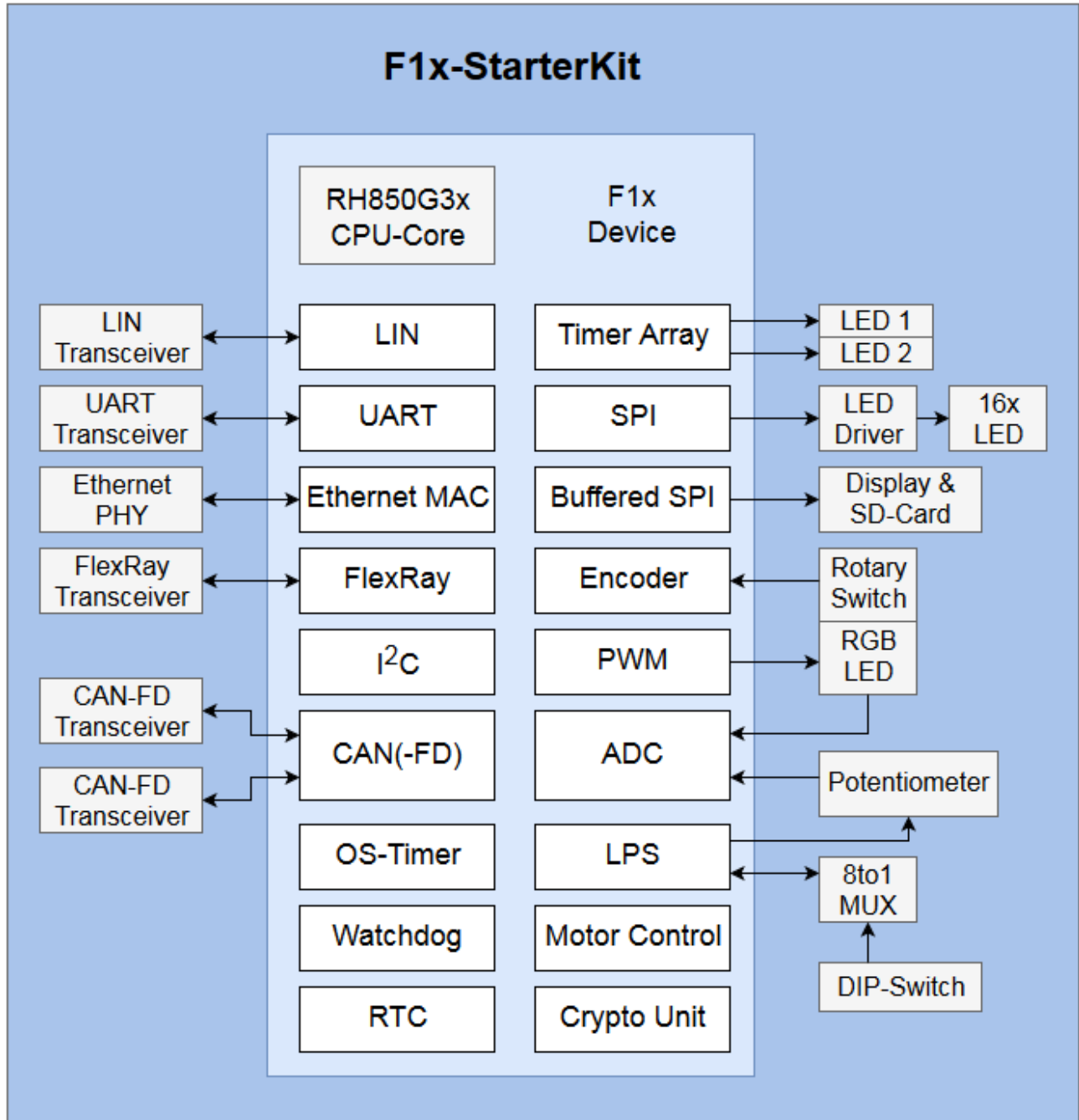

Figure 6. *Functional Overview*

**Note:** RH850/F1L version of the Starter Kit does not support CAN-FD function. Only High Speed Can is supported.

FlexRay and Ethernet function is available on RH850/F1H, F1KM-S4 and F1KH-D8 version only.

## 4.2 Functional Areas

The functional areas provide various circuits and components useful for interacting with the microcontroller's I/O:

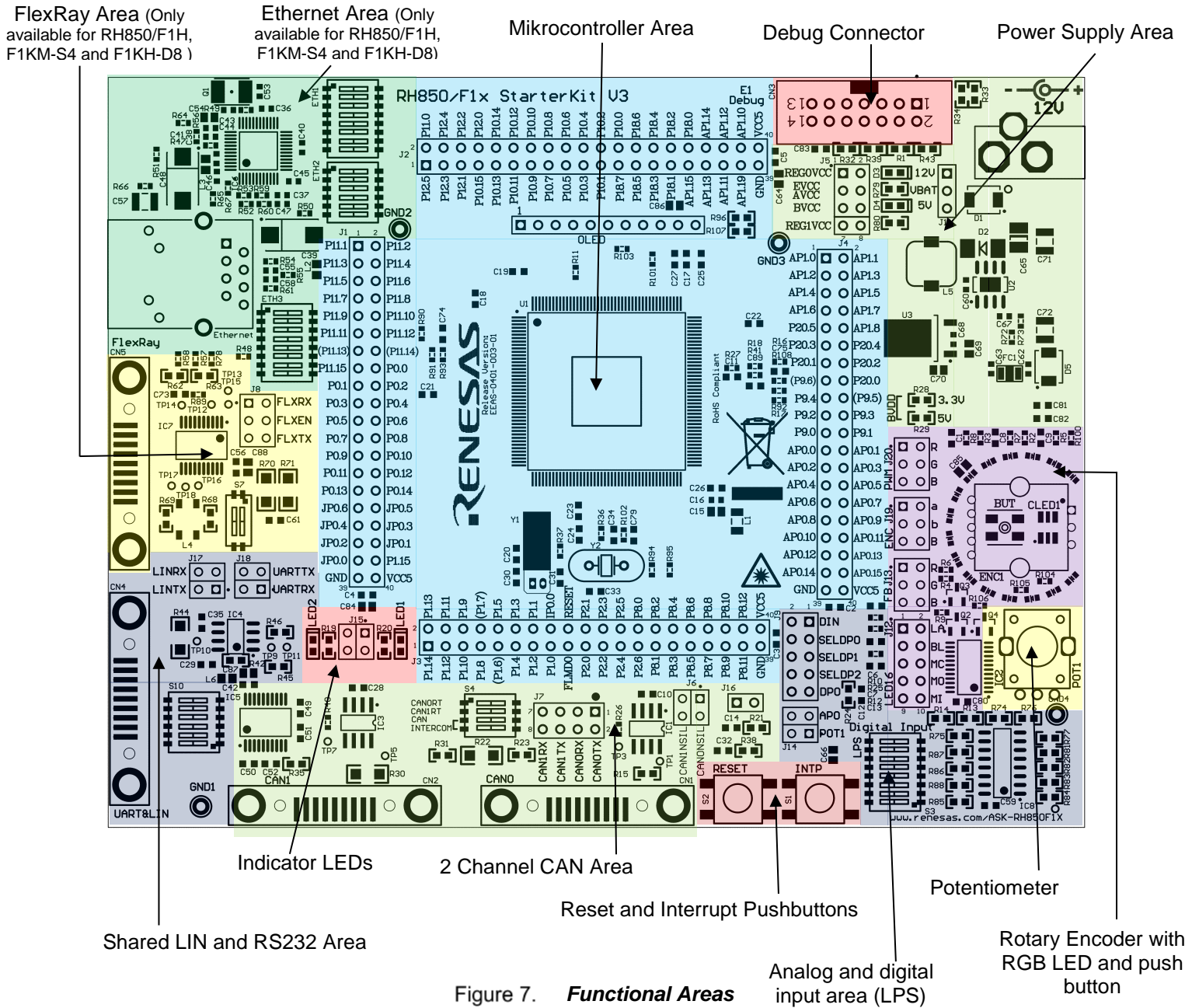

Figure 7. **Functional Areas**



## 4.2.1 Power Supply

### 4.2.1.1 Power supply configuration

The StarterKit provides two options for powering the board's integrated circuits. It is possible to supply the StarterKit by using the E1 Debugger or it is possible to supply the StarterKit by using an external 12 Volt power supply.

With the default jumper setting (see 0) the StarterKit is configured to be power supplied by the E1 Debugger.

The operation of the LIN and the FlexRay interface is only possible by using an external 12 Volt power supply.

When the board is supplied externally by 12 Volt, please choose the following jumper settings:

Jumper	Description	Setting	Note
J11	VBAT selector	1-2	closed (12V)
		2-3	Open
J10	Voltage regulator output to VDD Connector <i>(only available on StarterKit Release Version EEAS-0401-002-01)</i>	1-2	closed

**Table 4. Jumper setting for external 12 volt power supply**

When the board is supplied by E1 debugger, please choose the following jumper settings:

Jumper	Description	Setting	Note
J11	VBAT selector	1-2	open
		2-3	closed (5V)
J10	Voltage regulator output to VDD Connector <i>(only available on StarterKit Release Version EEAS-0401-002-01)</i>	1-2	open

**Table 5. Jumper setting for power supply by E1 Debugger**

The power supply area includes a DC jack type connector for providing external power supply to the StarterKit and its components. The external supply is reversibly protected against overvoltage. Nevertheless, please always observe the right polarity and voltage.

Connector	Description	Input Voltage Range
PowerCon	DC Power Jack ID=2.0mm, center positive	+10V to +15V

**Table 6. Power supply connector specification**

The two indicator LEDs (D3 and D4) are showing which power supply voltages are available.

#### 4.2.1.2 Power supply measurement

The current which is consumed by MCU can be measured by using J5. The appearance of J5 is different on the two Release Version. Please find below a description of the different versions.

##### RH850/F1L and RH850/F1K:

Jumper	Description	Pins	Note
J5	MCU power measurement	1-2	REGVCC power supply (5 V)
		3-4	EVCC, AV0REF, A1VREF power supply (5 V)
		5-6	BVCC (5 V)
		7-8	(not used)

**Table 7.** RH850/F1L and RH850/F1K MCU power measurement on Release Version EEAS-0401-003-01

Jumper	Description	Pins	Note for RH850/F1L and RH850/F1K
J5	MCU power measurement	1-2	REGVCC power supply (5 V)
		3-4	Total MCU power supply (5 V)

**Table 8.** RH850/F1L and RH850/F1K MCU power measurement on Release Version EEAS-0401-002-01

##### RH850/F1H and RH850/F1KM-S4:

Jumper	Description	Pins	Note
J5	MCU power measurement	1-2	REGVCC power supply (5 V)
		3-4	EVCC, AV0REF, A1VREF power supply (5 V)
		5-6	BVCC (3,3 V)
		7-8	(not used)

**Table 9.** RH850/F1H MCU power measurement on Release Version EEAS-0401-003-01

#### 4.2.2 Microcontroller Area and Port Pin Interfaces

On the different versions of the RH850/F1x StarterKit the following device are assembled:

Y-ASK-RH850F1L-V3:	R7F701057
Y-ASK-RH850F1K-V3:	R7F701587
Y-ASK-RH850F1H-V3:	R7F701527
Y-ASK-RH850F1KM-S4-V3:	R7F701649
Y-ASK-RH850F1KH-D8-V3:	R7F701709

As external clock supply of the microcontroller, a 16MHz crystal oscillator and a 32.768kHz sub-oscillator is mounted.

Each microcontroller I/O pin is connected to a pin header interface. The pin header interfaces allow easy probing of I/O pins and provide the ability to selectively connect the I/O pins to power, ground or other signals. Table 1 and Table 2 are showing the assignment of the pin header interface.

Certain GPIO pins of the device might not be available on all StarterKit versions. An overview of these pins can be found in Table 10.

Pin availability				
	F1L/F1K	F1H	F1KM-S4	F1KH-D8
P1_6	•	•	-	-
P1_7	•	•	-	-
P9_5	•	-	-	-
P9_6	•	-	-	-
P11_13	•	•	-	-
P11_14	•	•	-	-

**Table 10.** GPIO pins available on different board version (•: available, -: not available)

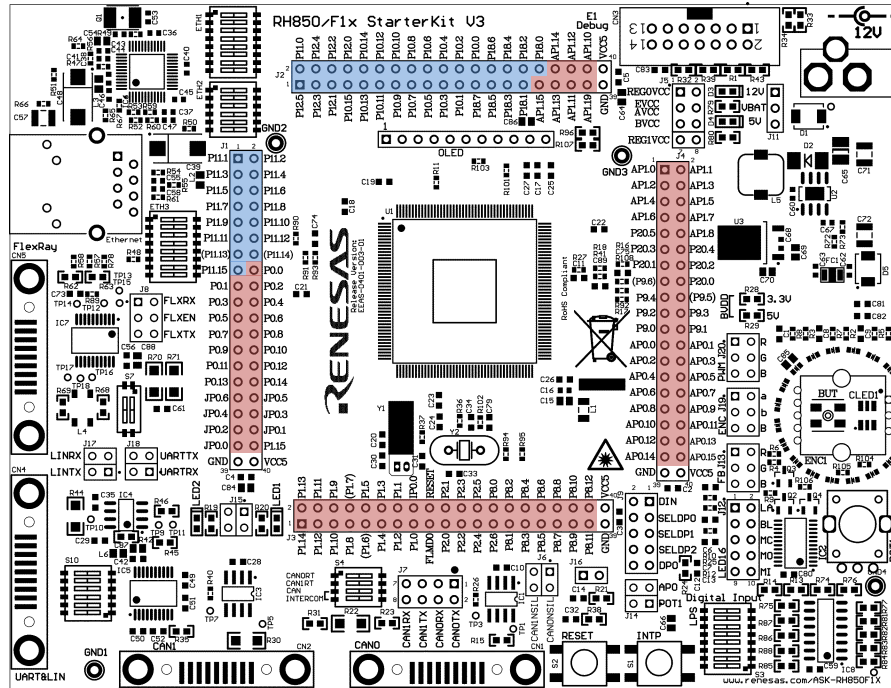

Figure 8. Power Supply of Pin Groups

	Port power supply groups				
	F1L	F1K	F1H	F1KM-S4	F1KH-D8
<b>BVCC (P10,P11,P12,P18)</b>	5V	5V	3,3V	3,3V	3,3V
<b>All other power supplies expect BVCC</b>	5V	5V	5V	5V	5V

Table 11. Port power supply groups

In the RH850/F1H, F1KM-S4 and F1KH-D8 versions of the board a 3.3V regulator is supplied to provide the required voltage for the Ethernet transceiver. This voltage is supplied to the BVCC Pin Group Power Supply and will affect the ports P10, P11, P12 and P18 (blue area in Figure 8). All other port pins operate at 5 V (red area in Figure 8). For RH850/F1L and RH850/F1K all port pins operate at 5 V.

### 4.2.3 LEDs

#### 4.2.3.1 RGB LED

A RGB LED is provided to allow visual observation of microcontroller output port state and to show the functionality of the PWM Diagnostic Macro. The RGB LED, which is part of the Rotary Encoder, is driven by three N-channel transistor. A feedback for each RGB LED channel is

connected to the A/D converter of the microcontroller to evaluate the LED drive state. The LED PWM signals are active high.

Please use the following jumper configuration to activate the full RGB LED functionality:

Jumper	Description	Setting	Note
J20	RGB LED PWM connector	1-2	Red PWM channel ↔ P20_1
		3-4	Green PWM channel ↔ P20_2
		5-6	Blue PWM channel ↔ P20_3
J13	RGB LED feedback connector	1-2	Red LED feedback channel ↔ AP0_1
		3-4	Green LED feedback channel ↔ AP0_2
		5-6	Blue LED feedback channel ↔ AP0_3

**Table 12. White RGB Signals Configuration**

#### 4.2.3.2 Green Indicator LEDs

Two green low power LEDs (LED1 and LED2) are provided to allow visual observation of microcontroller output port states. The LED signals are active high.

Jumper	Setting	LED	Device Port
J15	1-2	LED1	P0_11
	3-4	LED2	P8_5

**Table 13. Green Indicator LED Signals**

#### 4.2.3.3 Blue Power Supply LEDs

Two blue LEDs (D5 and D6) are provided to allow visual observation of the power supply status.

LED	Note
D3	12 Volt power supply
D4	5 Volt power supply

**Table 14. Blue Power Supply LED Signals**

#### 4.2.3.4 Blue LED Circle

Sixteen blue LEDs are driven by the TLC5925, which can be controlled by the SPI command to change the output states.

Jumper	Setting	Signal	Device Port
J12	1-2	LAT	P1_14
	3-4	BLNK	P1_15
	5-6	MCLK	P0_14
	7-8	MOSI	P0_13
	9-10	MISO	P0_12

**Table 15. Blue LED Circle Signals**

#### 4.2.4 Digital inputs for Low Power Sampler (LPS)

Eight digital input signals, which are generated by a DIP switch array (S3), are provided to trigger the microcontroller's Low Power Sampler. The input signals are connected to the microcontroller via 8 to 1 Multiplexer (IC4). When the DIP switches (S3) are changed during low power mode (DeepSTOP mode), the microcontroller will wake up.

Please use the following jumper configuration to connect the DIP Switch and multiplexer to the microcontroller

Jumper	Description	Setting	Note
J9	Digital LPS input to MCU connector	1 – 2	DIN ↔ P8_1
		3 – 4	SELDP0 ↔ P0_4
		5 – 6	SELDP1 ↔ P0_5
		7 – 8	SELDP2 ↔ P0_6
		9 – 10	DPO ↔ P0_0

**Table 16. LPS Jumper Configuration**

#### 4.2.5 Pushbutton Switches

Two pushbutton switches (S1 and S2) are provided to allow the switching of microcontroller input port states. The switches are active low and normally open.

Switch	Device signal	Active Level	Inactive State
S1	P0_9 (INTP12)	low	open
S2	RESET	low	open

**Table 17. Pushbutton Switch Signals**

Please use the following jumper configuration to connect the interrupt pushbutton switch (S1) to the microcontroller.

Jumper	Description	Setting	Note
J16	Interrupt Button to MCU connector	1-2	Button ↔ P0_9

**Table 18. Interrupt Pushbutton Jumper Configuration**

Additionally a pushbutton is provided with the Rotary Encoder. For details please refer to Rotary Encoder with Pushbutton.

#### 4.2.6 Analog Input - Potentiometer

A potentiometer (POT1) is provided to generate an analog voltage, which can be provided to the microcontroller's analog input pins.

By turning the potentiometer POT1, a voltage derived from the MCU output signal APO (P0\_1) can be adjusted. The APO signal can be controlled by the Low Power Sampler (LPS) macro. If the LPS macro is not used, APO has to be set to high manually (use P0\_1 as general purpose digital output).

Potentiometer	Analog Input MCU
POT1	AP0_0

**Table 19. Analog Input Signal**

Please use the following jumper configuration to connect the potentiometers to the microcontroller:

Jumper	Description	Setting	Note
J14	Potentiometer to MCU Connector	1-2	POT1 ↔ AP0_0
		3-4	POT1 supply ↔ APO

**Table 20. Potentiometer Jumper Configuration**

#### 4.2.7 Rotary Encoder with Pushbutton Switch

An incremental Rotary Encoder (ENC1) is provided on the starter kit. The outputs *ENC1\_a* and *ENC1\_b* of the Rotary Encoder can be connected to the microcontroller internal encoder timer via jumpers. In addition the Rotary Encoder (ENC1) incorporates a pushbutton switch *ENC1\_Switch*, which can also be connected to a pin of the microcontroller via jumper. The switch is active low and normally open.

Jumper	Description	Setting	Note
J19	Encoder to MCU connector	1-2	P10_9 ↔ ENC1_a
		3-4	P10_10 ↔ ENC1_b
		5-6	P1_4 ↔ ENC1_Switch

**Table 21. Encoder Jumper Configuration**

## 4.2.8 Serial Communication Interfaces

### 4.2.8.1 RS232 and LIN

RS232 transceiver (IC5) is supplied to provide a serial interface. The transceiver can be connected to the microcontroller's UART macro (RLIN30).

Please close the following jumpers to connect the RS232 transceiver to the microcontroller:

Jumper	Description	Setting	Note
J18	RS232 Transceiver to MCU connector	1-2	R232 TX ↔ P0_2
		3-4	R232 RX ↔ P0_3

**Table 22. RS232 Transceiver Jumper Configuration**

Local Interconnect Network (LIN) transceiver (IC4) is supplied to provide a LIN interface. The transceiver can be connected to the microcontroller's LIN macro (RLIN21).

Please close the following jumpers to connect the LIN transceiver to the microcontroller:

Jumper	Description	Setting	Note
J17	LIN Transceiver to MCU connector	1-2	LIN RX ↔ P0_7
		3-4	LIN TX ↔ P0_8

**Table 23. LIN Transceiver Jumper Configuration**

The serial interfaces are connected to the DB9 connector CN4 via DIP switch S10.

The DB9 connector CN13 is shared between the board's RS232 and LIN interface. Only one interface can be used at the same time. Please the configuration for RS232 in Table 24 and for LIN in Table 25.

Switch	Configuration	Signal	DB9 pin (CN14)
S10	1	on	RS232 TX
	2	on	RS232 RX
	3	off	-
	4	off	-
	5	off	-
	6	off	-

**Table 24. Switch S10 configuration for RS232**



Switch	Configuration	Signal	DB9 pin (CN14)	
S10	1	off	-	2
	2	off	-	3
	3	on	Ground	5
	4	on	VBAT (12V DC)	9
	5	on	LIN	7
	6	on	Ground	3

**Table 25. Switch S10 configuration for LIN**

**Caution:** Please ensure that only one interface is configured for operation at the same time (either RS232 or LIN) by using DIP switch S10.

#### 4.2.8.2 CAN Interfaces

Controller Area Network (CAN) transceivers (IC1 and IC3) are supplied to provide two CAN bus interfaces. Each transceiver can be connected to one of the microcontroller's CAN interfaces (CAN3, CAN4). The CAN bus interfaces are connected to the DB9 connectors CN1 and CN2. The CAN0/1 transceiver is enabled by default and able to transmit and receive data via the CANH and CANL bus lines. The mode can be changed by setting a low level on the NSIL pin and on the STBY pin selects silent mode via Microcontroller GPIO pin (P1\_1 / P2\_6). This receive-only mode can be used to test the connection of the bus medium. In silent mode it can still receive data from the bus, but the transmitter is disabled and therefore no data can be sent to the CAN bus. DIP switch S4 provides additional CAN bus interface configuration options including the ability to selectively interconnect CAN bus interfaces on-board.

The CAN transceiver support CAN and CAN-FD communication.

Please close the following jumpers to connect the CAN0 transceiver (IC1) and CAN1 transceiver (IC3) to the microcontroller:

Jumper	Description	Setting	Note
J7 (optional)	CAN0 transceiver TX/RX to MCU connector	1 – 2	CANTX0 ↔ P1_3
		3 – 4	CANRX0 ↔ P1_2
	CAN1 transceiver enable to MCU connector	5 – 6	CANTX1 ↔ P1_12
		7 – 8	CANRX1 ↔ P1_13

**Table 26. CAN0 and CAN1 Transceiver Jumper Configuration**

Please close the following jumpers to connect the CAN0 transceiver (IC1) /CAN1 transceiver (IC3) to the microcontroller to change the transceiver mode:

Jumper	Description	Setting	Note
J6	CAN0 and CAN1 transceiver NSIL to MCU connector	1 – 2	CANNSIL0 ↔ P1_1
		3 – 4	CANNSIL0 ↔ P2_6

**Table 27. CAN Transceiver NSIL Jumper Configuration**

The on-board CAN bus and the terminal resistors of each CAN channel can be activated by DIP switch S4.

Transceiver	CAN channel	Switch	Note
IC1	CAN0	1	Enable termination resistor
IC3	CAN1	2	Enable termination resistor
All	All	3	Connect to on-board CAN bus
		4	Connect to on-board CAN bus

**Table 28. DIP Switch S4 - CAN Interfaces Signals**

#### 4.2.8.3 FlexRay Interface (RH850/F1H, F1KM-S4 and F1KH/D8 version only)

*FLEXRAY* transceiver (IC7) is supplied to provide a *FLEXRAY* bus interface. The transceiver can be connected to the microcontroller's *FLEXRAY* interface (FLXA). The FR bus interface is connected to the DB9 connector CN5. The FR transceiver is enabled by default. DIP switch S7 provides additional FR bus interface configuration options including the ability to selectively interconnect FR bus interfaces on-board.

Please close the following jumpers to connect the *FLEXRAY* transceiver (IC7) to the microcontroller:

Jumper	Description	Setting	Note
J8	FLEXRAY transceiver TX/RX to MCU connector	1-2	FR_RXD ↔ P10_14
		3-4	FR_TXEZ ↔ P10_11
		5-6	FR_TXD ↔ P11_1

**Table 29. FR Transceiver Jumper Configuration**

The on-board *FLEXRAY* bus and the terminal resistors of each *FLEXRAY* channel can be activated by DIP switch S7.

Transceiver	Switch	Note
IC7	1	Enable termination resistor
	2	Enable termination resistor

**Table 30. Dip Switch S7 - FR Interfaces Signals**

#### 4.2.8.4 Ethernet Interface RH850/F1H, F1KM-S4 and F1KH/D8 version only)

Ethernet PHY (IC6) is supplied to provide an external *T100Base-TX Ethernet* bus interface. The transceiver can be connected to the microcontroller's Ethernet interface ETNB via the DIP switches ETH1 – ETH3.

Please use the following DIP switch configuration to connect the Ethernet transceiver to the microcontroller:

Switch	Setting	Note	
ETH1	1	on	ETH0LINK ↔ P18_0
	2	on	ETH0TXD0 ↔ P18_1
	3	on	ETH0TXD1 ↔ P18_2
	4	on	ETH0TXD2 ↔ P18_3
	5	on	ETH0TXD3 ↔ P18_4
	6	on	ETH0TXEN ↔ P18_5
	7	on	ETH0TXERR ↔ P18_6
	8	on	ETH0TXCLK ↔ P18_7

**Table 31. DIP Switch ETH1**

Switch	Setting	Note	
ETH2	1	on	ETH0RXCLK ↔ P10_0
	2	on	ETH0RXD0 ↔ P10_1
	3	on	ETH0RXD1 ↔ P10_2
	4	on	ETH0RXD2 ↔ P10_4
	5	on	ETH0RXD3 ↔ P10_5
	6	X	No function

**Table 32. DIP Switch ETH2**

Switch	Setting	Note	
ETH3	1	on	ETH0RESETB ↔ P11_9
	2	on	ETH0COLSD ↔ P11_10
	3	on	ETH0RXDV ↔ P11_11
	4	on	ETH0CRS ↔ P11_13
	5	on	ETH0RXERR ↔ P11_14
	6	on	ETH0MDIO ↔ P12_4
	7	on	ETH0MDC ↔ P12_5
	8	on	ETH0INT ↔ P11_6

**Table 33. DIP Switch ETH3**

#### 4.2.9 On-chip Debug and Flash Programming Connector

Connector CN3 is provided to allow the connection of microcontroller debug and flash programming tools. Connector CN3 is a 14 pin, 0.1" pin pitch connector. The pinout of this connector supports the Renesas E1 On-chip debug emulator. For more information about E1, please see Chapter 5.1 *E1 On-Chip Debug Emulator* [R0E000010KCE00].

#### 4.2.10 OLED Board (optional)

The StarterKit offers a pin header to optionally connect an external display to the board. For example following *OLED* Display with *microSD* card holder is compatible to the connector:

<https://www.adafruit.com/products/1673>

Header	Pin number	signal	Note
Display	1	MOSI	P11_2
	2	SCK	P11_3
	3	DC(data command)	P11_0
	4	RESET	P10_12
	5	OLEDCS	P11_15
	6	SDCS	P12_1
	7	MISO	P11_4
	8	CD(card detected)	P11_5
	9	3Vo	AP0_4
	10	Vin	VDD_5V
	11	GND	GND

**Table 34. OLED header (optional)**

## 5. Development tools

### 5.1 E1 On-Chip Debug Emulator [R0E000010KCE00]

The *E1 On-Chip Debug Emulator* is a powerful debugging tool with flash programming functions which supports various Renesas microcontrollers.

Updates and User Manuals for this tool can be found on the Renesas website:

<http://www.renesas.com/e1>

### 5.2 Development Software

The following development software tools are included in the StarterKit package:

- Green Hills MULTI IDE (90 day evaluation version)
- IAR Embedded Workbench for Renesas RH850 (128KB Kickstart version)
- iSYSTEM winIDEA with E1 support
- CS+ integrated development environment (Evaluation Version via download)
- Renesas Flash Programmer (RFP)
- Code generator tool AP4 for RH850/F1K

More information about the usage of these software tools is shown in the Quick Start Guide which is also part of the StarterKit package.

## 6. RH850/F1x StarterKit Example Software

The included demo software provides the following functions:

- Basic MCU Initialization
- PWM Generation for user LEDs and RGB LEDs
- PWM Diagnostic Function for RGB LEDs
- A/D-Converter for PWM-Diagnostics and Potentiometers
- Standby modes including Low Power Sampler (LPS)
- Push-Button Function
- Encoder Function
- CAN Frame Transmission
- LIN Frame Transmission
- UART Transmission
- SPI Transmission
- Operating System Timer
- Timer Array Unit J
- Timer Array Unit B
- Ethernet Demo with Webserver Application (RH850/F1H and RH850/F1KM-S4 only)

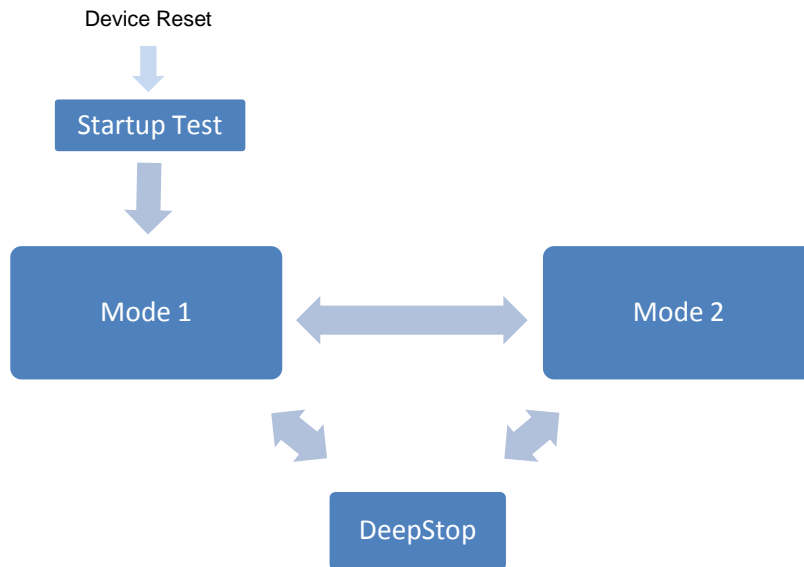

Figure 1. **Software flow**

The software contains a test function executed at the start and two run modes.

For live documentation of the RH850 actions connect your computer via the COM-Port to the UART connector “CN4” of the board.

**Note:** Use a 1:1 RS232 computer cable and a baud-rate of 9600.

## 6.1 StartUp Test

Once started, the clock will be initialized and a start-up test is performed. During the test, the LEDs of the Blue LED Circle will successively be turned on and then turned off in the same pattern. Simultaneously the RGB LED will sweep through different colors and then turn off. Afterwards the RGB LED will light up in white for 500ms, as well as the whole Blue LED Circle. LED1 and LED2 will light during the whole test. The Serial Interfaces CAN, LIN and Ethernet (if provided), the Display availability and the RGB LED PWM feedback signals are checked. The result is printed out in the debugger and via UART. After this the SW continues with Mode 1.

## 6.2 Mode 1

LED1 and LED2 glow in different intensities depending on the potentiometer POT1 position. The converted analogue value of POT1 is used to update the duty cycle of the PWM module which drives these LEDs. The LEDs of the Blue LED Circle follow the Rotary Encoder ENC1. By pressing the Rotary Encoder Pushbutton, the color of the RGB LED is changed.

The load current through each of the RGB LEDs is evaluated by converting feedback/sense

signal into digital values and applying conversion result upper / lower limit check function of ADC (PWM diagnostic function). In case the measured current is either too high or too low, a fault is assumed and in turn the PWM of the corresponding LED is switched OFF. By switching to Mode 2 the PWM output and diagnostic is started again.

If Ethernet is available (RH850/F1H and RH850/F1KM-S4 only) the corresponding Webserver Handler is called periodically.

A short push on pushbutton S1 will switch to mode 2, holding it pressed for 3s or more will switch to DeepSTOP mode.

After 30s without user action, the microcontroller will enter DeepSTOP mode on its own.

Mode 1 is called in a 1ms cycle using the Operating System Timer.

### 6.3 Mode 2

LED1 and LED2 blink alternately and the LEDs of the Blue LED Circle run around the Rotary Encoder in a specific frequency. The frequency is determined by the analogue value of POT1 which is converted to a corresponding Timer Array Unit J interval time. After each interval, the duty cycle of the LEDs LED1 and LED2 is adjusted to generate the alternatively blinking pattern, as well as the positions of the Blue LED Circle. The number of blue LEDs which are circling can be increased/decreased by the Rotary Encoder ENC1.

The load current through each of the RGB LEDs is evaluated by converting feedback/sense signal into digital values and applying conversion result upper / lower limit check function of ADC (PWM diagnostic function). In case the measured current is either too high or too low, a fault is assumed and in turn the PWM of the corresponding LED is switched OFF. By switching to Mode 1 the PWM output and diagnostic is started again.

If Ethernet is available (RH850/F1H and RH850/F1KM-S4 only) the corresponding Webserver Handler is called periodically.

A short push on pushbutton S1 will switch to mode 1, holding it pressed for 3s or more will switch to DeepSTOP mode.

After 30s without user action, the microcontroller will enter DeepSTOP mode on its own.

Mode 2 is called in a 1ms cycle using the Operating System Timer.



## 6.4 StandBy

Entering standby mode will turn off all unnecessary functions and switch the controller into DeepSTOP for low power consumption. This is indicated by a 2s interval of LED2 generated by the Timer Array Unit J.

A wake-up can be performed by a short push the pushbutton S1, the Rotary Encoder Pushbutton , changing the configuration of the DIP switch S3 or turning potentiometer POT1 more than 25% of the actual state. DIP switch and POT1 related wake-up events are generated by using the Low Power Sampler triggered by Timer Array Unit J in a 500ms interval. Performing a wake-up will resume the last mode the SW was in before standby was entered.

## 6.5 Webserver Application

On StarterKits with available Ethernet (RH850/F1H and RH850/F1KM-S4 only) the open source TCP/IP Stack lwIP is implemented to provide webserver functionality. The website can be accessed via the IP address *192.168.0.2*. In Mode 1 and Mode 2 certain runtime information such as CPU load, received/transmitted frames, potentiometer value, RGB color and test results are present on the website. The data is transferred to the website via SSI, the corresponding XML document can be accessed via *192.168.0.2/status.ssi*.

Furthermore the Mode of the StarterKit (Mode 1, Mode 2, StandBy) as well as the RGB LED color can be controlled via CGI using buttons and a color picker implemented on the website.

## 7. Component Placement and Schematics

### 7.1 Component placement

#### 7.1.1 Release Version EEAS-0401-002-01

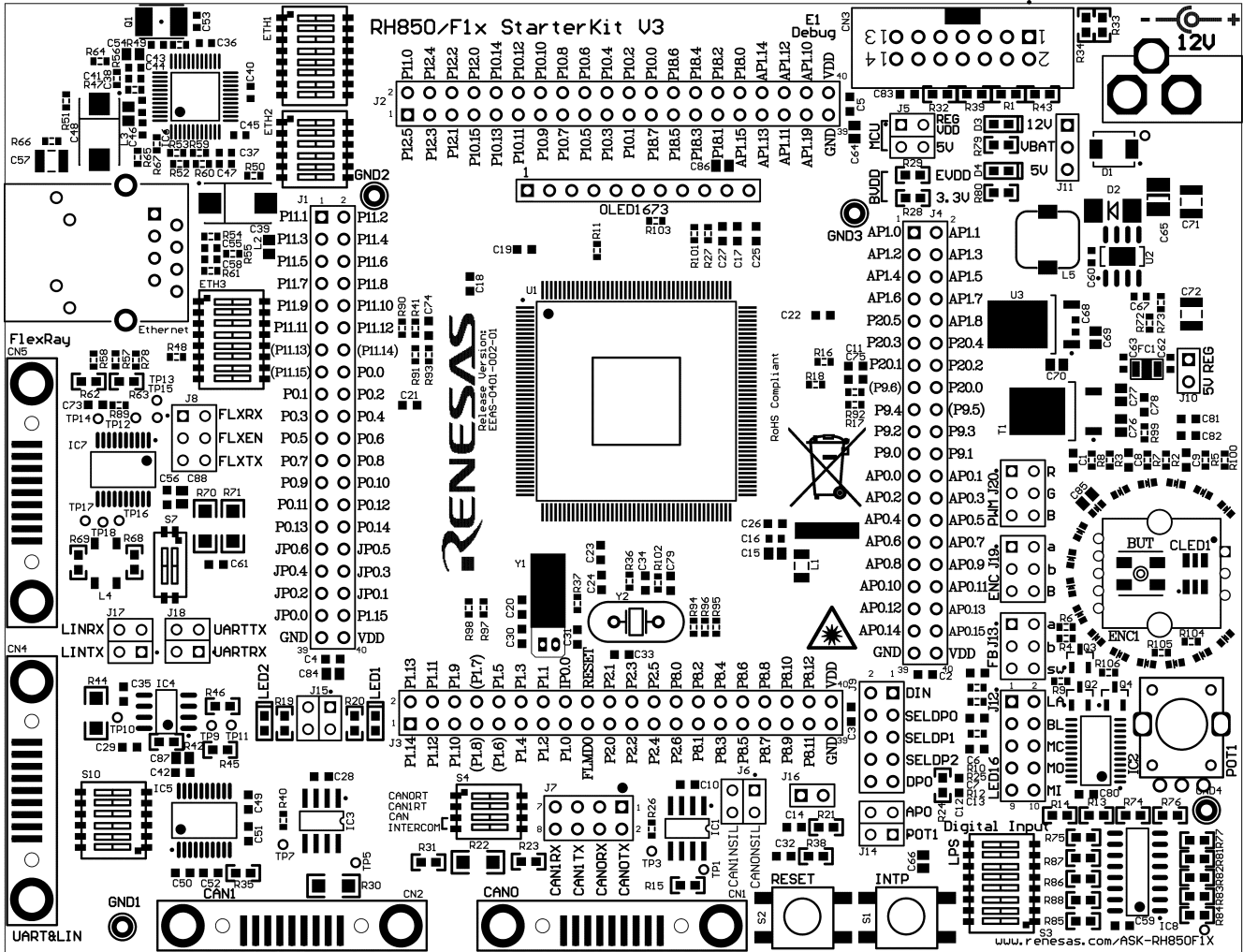

7.1.2 Release Version EEAS-0401-003-01

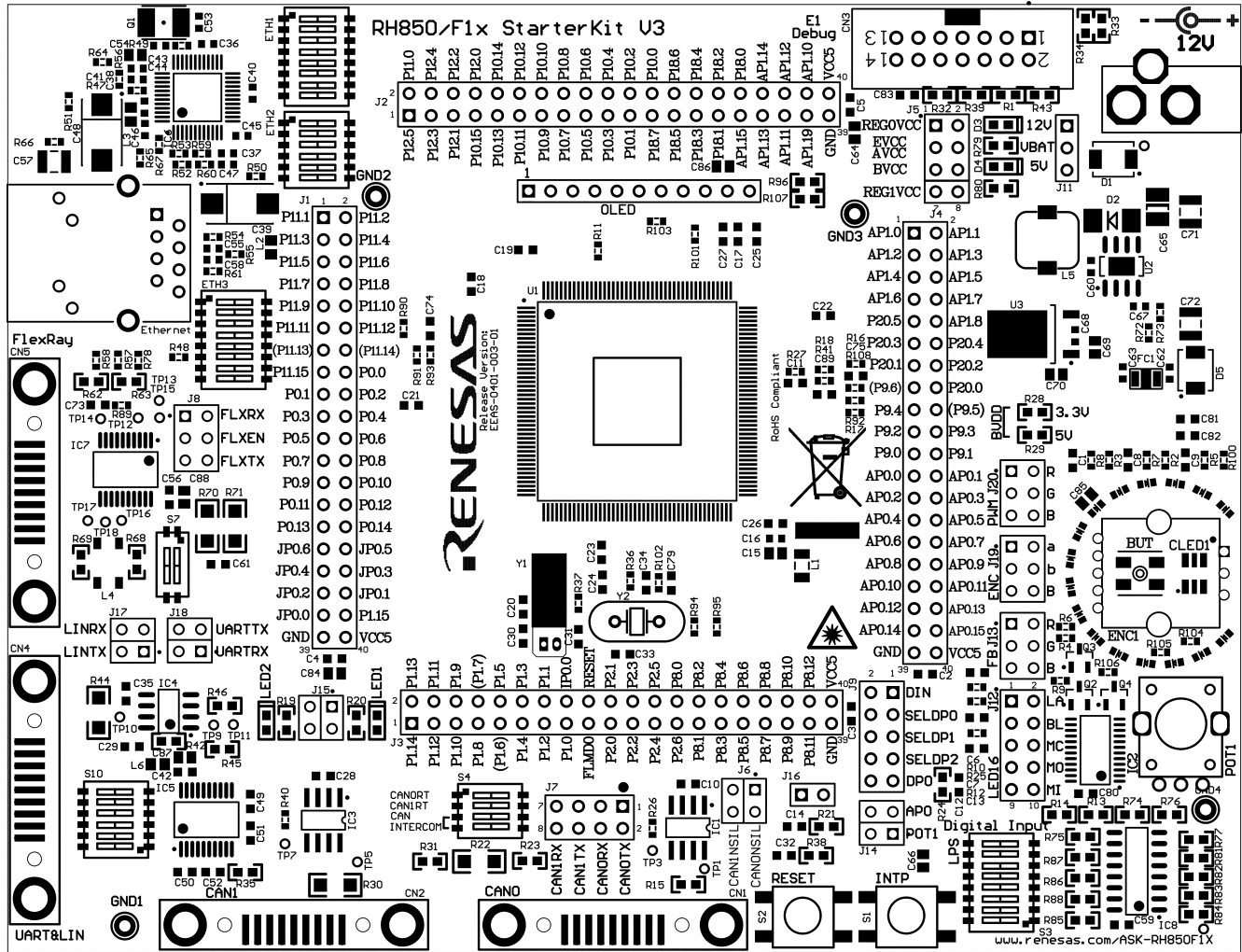

## 7.2 Schematics

### 7.2.1 Y-ASK-RH850F1L-V3 and Y-ASK-RH850F1K-V3 Schematics

#### 7.2.1.1 Release Version EEAS-0401-002-01

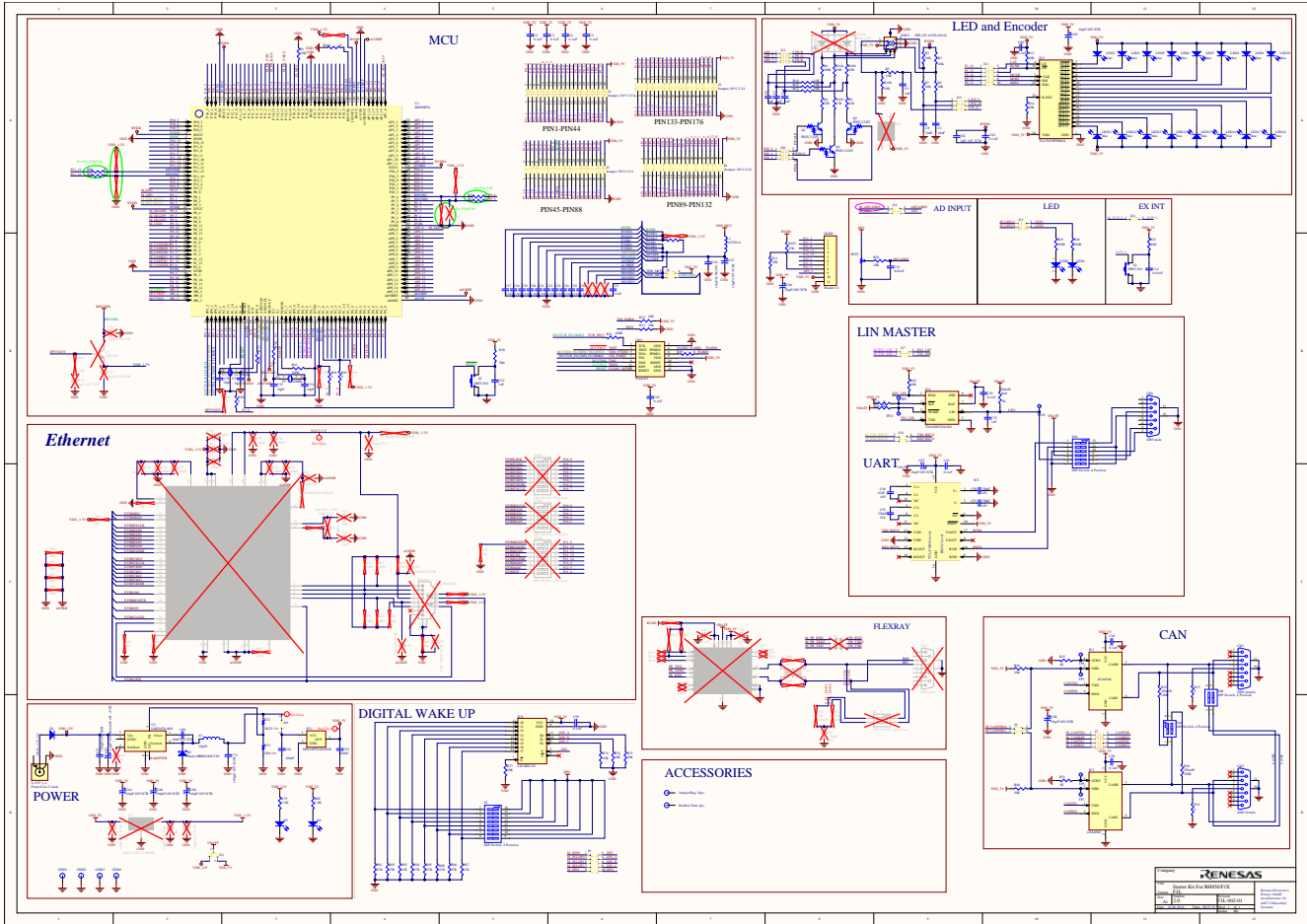

7.2.1.2 Release Version EEAS-0401-003-01

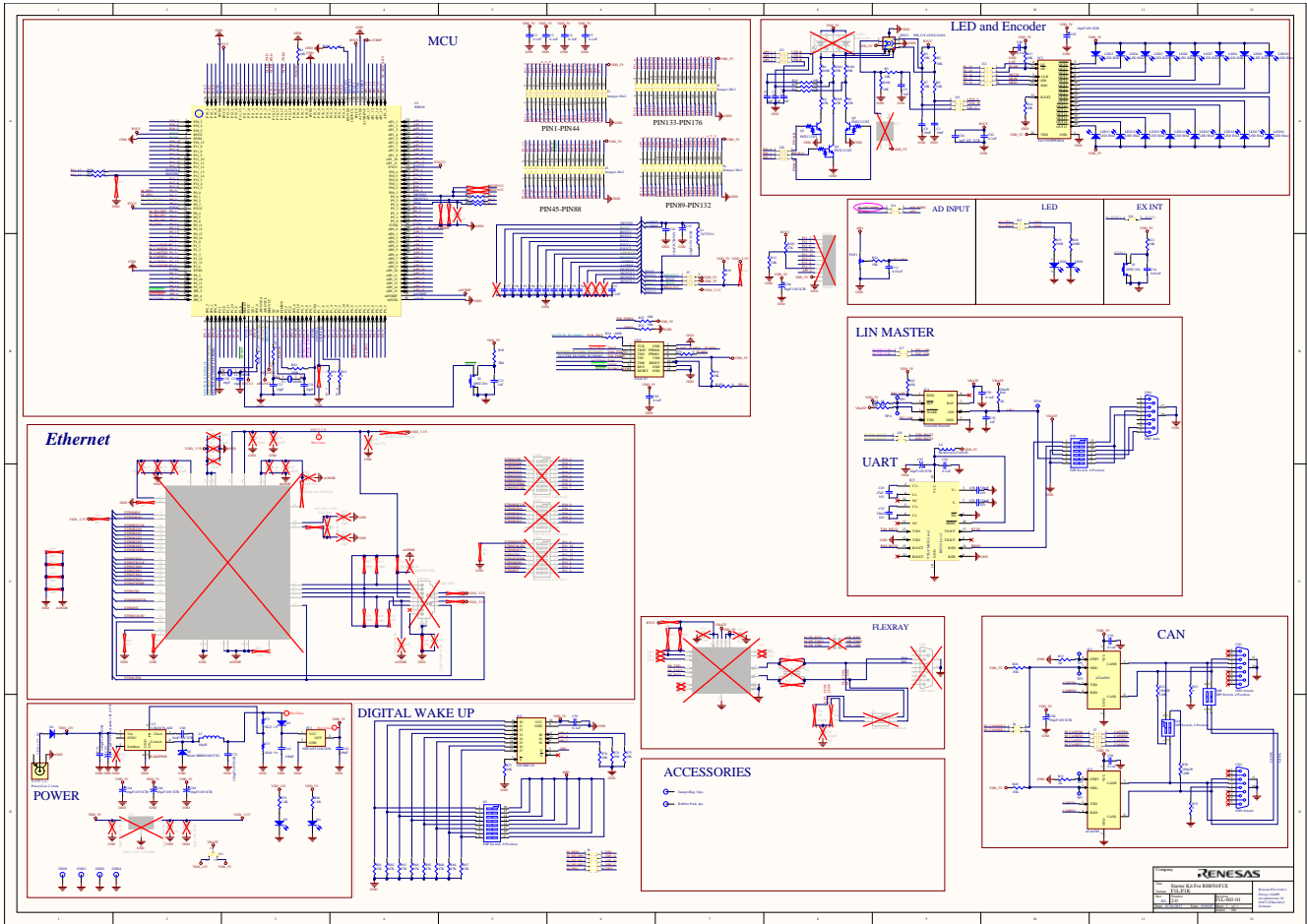

### 7.2.2 Y-ASK-RH850F1H-V3 Schematics

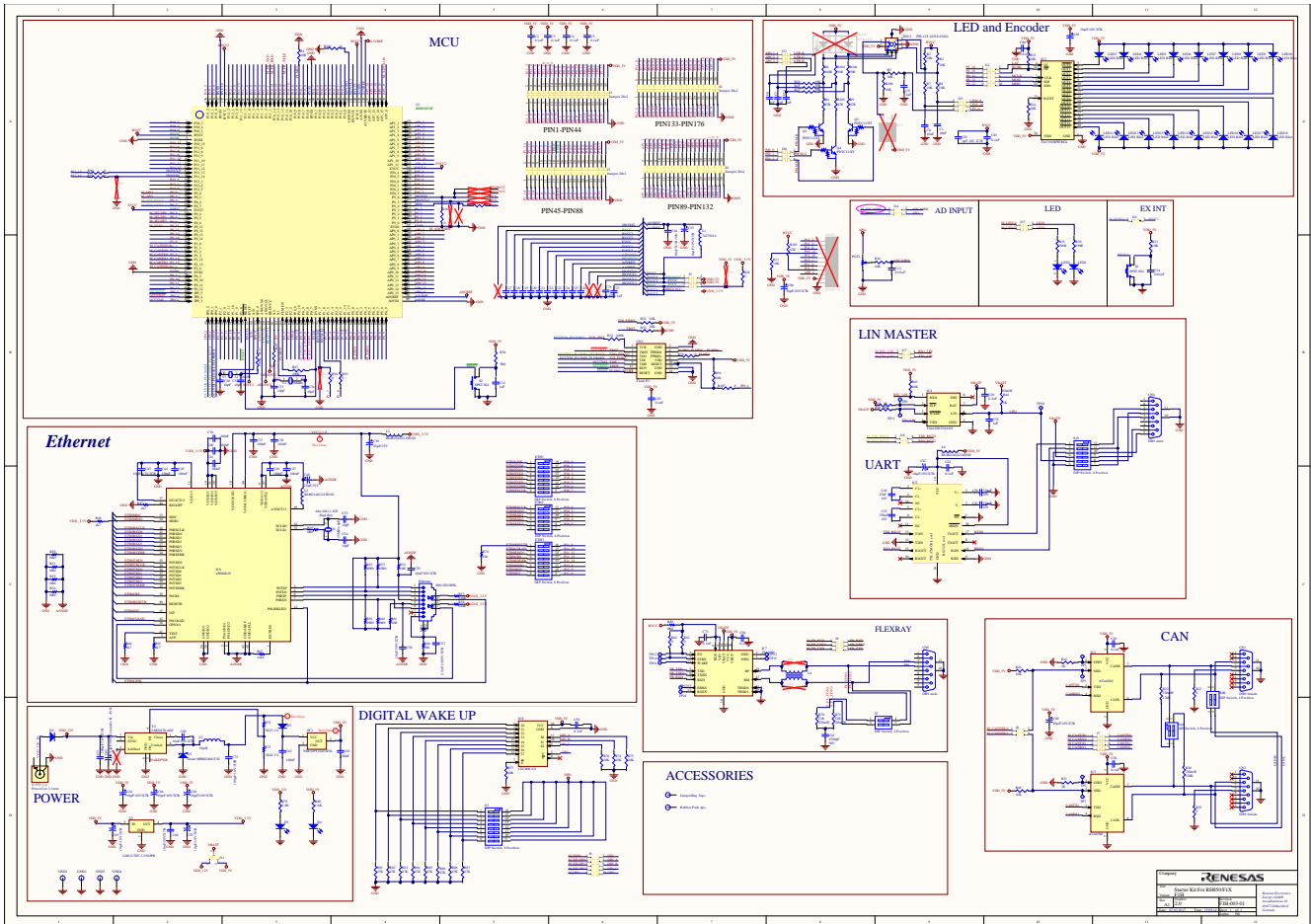

7.2.3 Y-ASK-RH850F1KM-S4-V3 Schematics

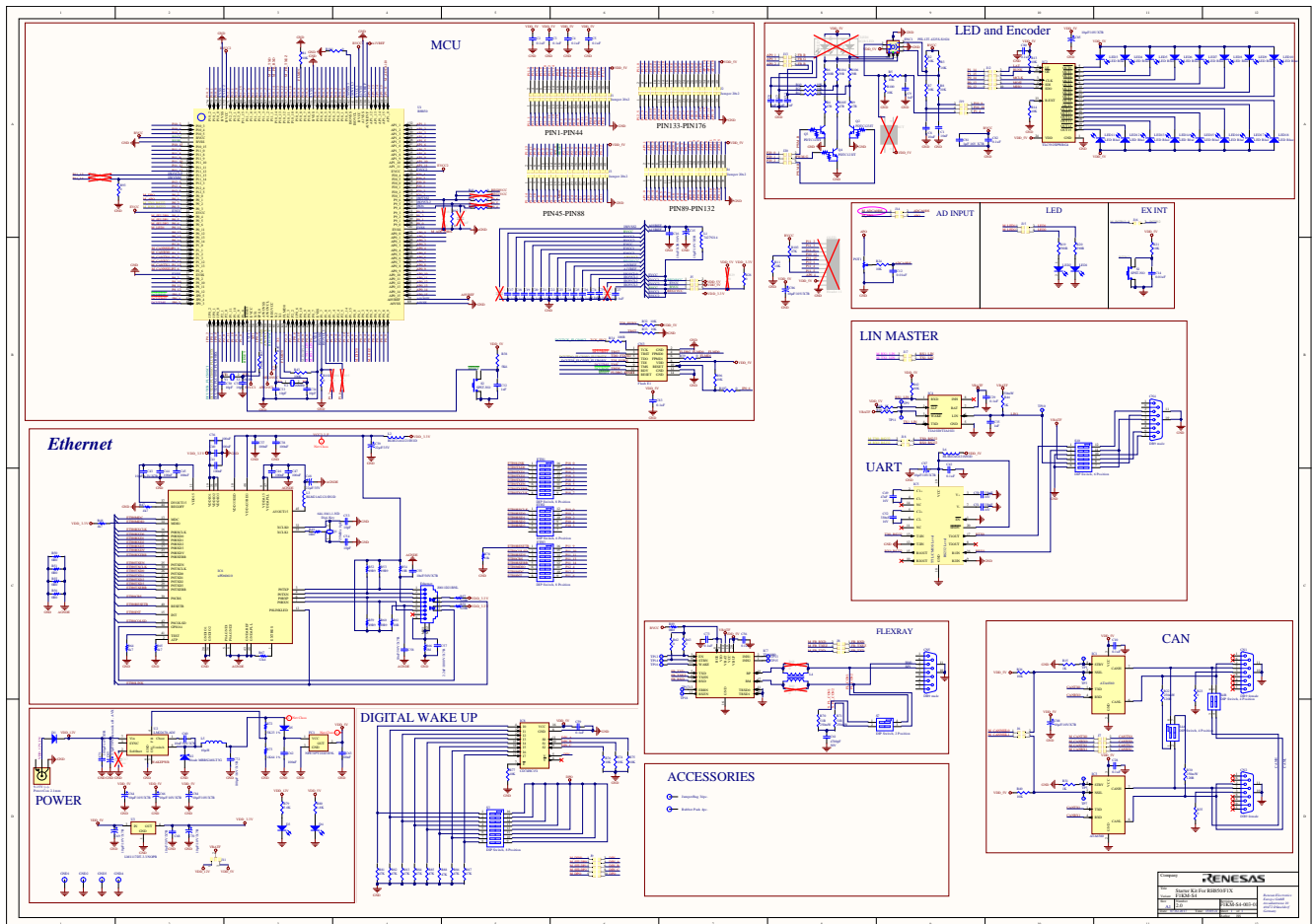

7.2.4 Y-ASK-RH850F1KH-D8-V3 Schematics

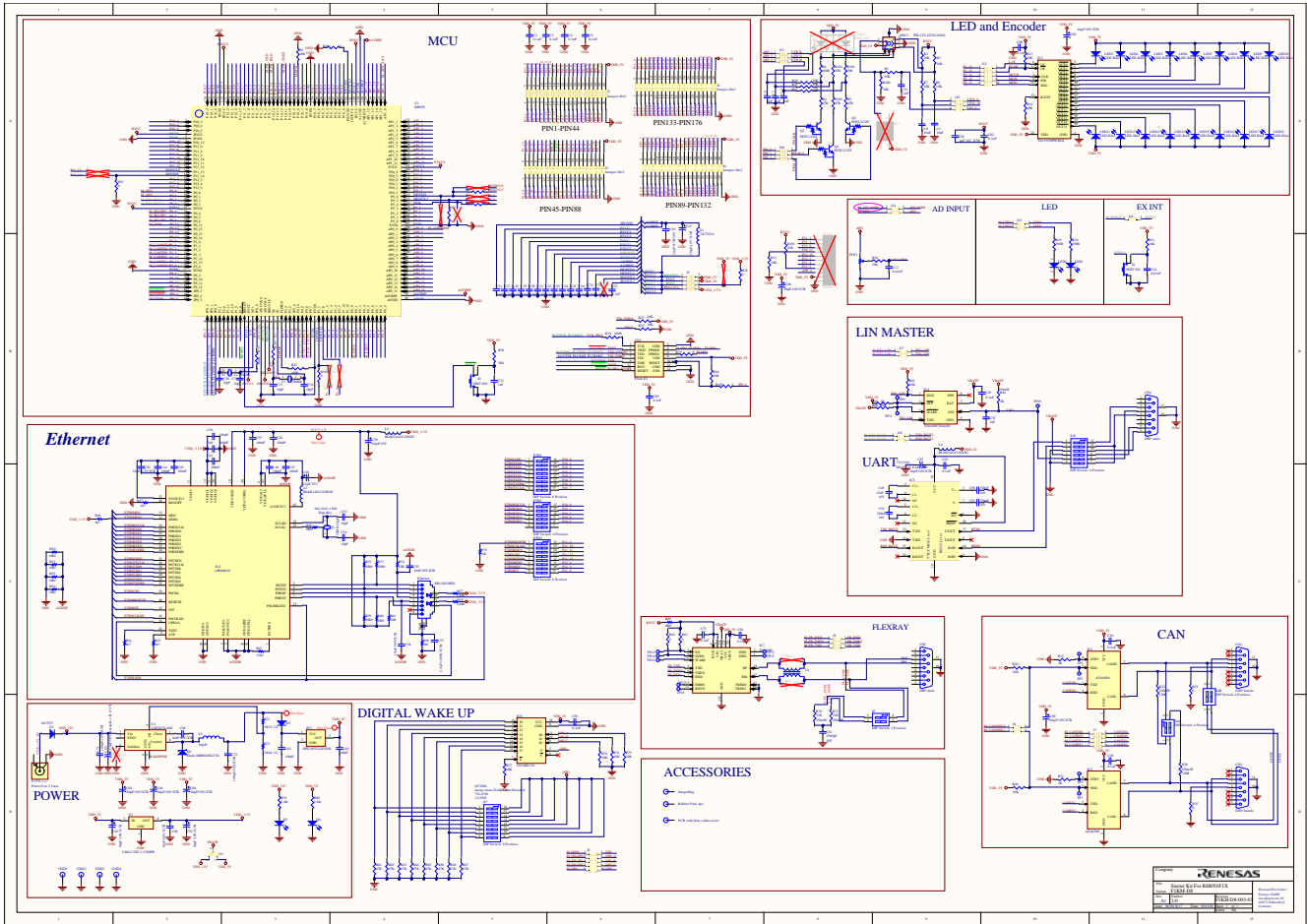



## 8. Revision History

RH850/F1x StarterKit V3 User Manual: Hardware
---

Rev.	Date	Description
		Summary
1.00	January 2017	First edition issued
1.10	May 2017	Information for RH850/F1KM-S4 and RH850/F1H added
1.20	January 2018	Information for RH850/F1KH-D8 added

---

RH850/F1x StarterKit V3 User Manual: Hardware

Publication Date: Rev. 1.20 January 2018

Published by: Renesas Electronics Europe

---



## Renesas Electronics Corporation

### SALES OFFICES

<http://www.renesas.com>

Refer to "<http://www.renesas.com/>" for the latest and detailed information.

**Renesas Electronics America Inc.**

2880 Scott Boulevard Santa Clara, CA 95050-2554, U.S.A.

Tel: +1-408-588-6000, Fax: +1-408-588-6130

**Renesas Electronics Canada Limited**

1101 Nicholson Road, Newmarket, Ontario L3Y 9C3, Canada

Tel: +1-905-898-5441, Fax: +1-905-898-3220

**Renesas Electronics Europe Limited**

Dukes Meadow, Millboard Road, Bourne End, Buckinghamshire, SL8 5FH, U.K

Tel: +44-1628-585-100, Fax: +44-1628-585-900

**Renesas Electronics Europe GmbH**

Arcadiastrasse 10, 40472 Düsseldorf, Germany

Tel: +49-211-65030, Fax: +49-211-6503-1327

**Renesas Electronics (China) Co., Ltd.**

7th Floor, Quantum Plaza, No.27 ZhiChunLu Haidian District, Beijing 100083, P.R.China

Tel: +86-10-8235-1155, Fax: +86-10-8235-7679

**Renesas Electronics (Shanghai) Co., Ltd.**

Unit 204, 205, AZIA Center, No.1233 Lujiazui Ring Rd., Pudong District, Shanghai 200120, China

Tel: +86-21-5877-1818, Fax: +86-21-6887-7858 / -7898

**Renesas Electronics Hong Kong Limited**

Unit 1601-1613, 16/F., Tower 2, Grand Century Place, 193 Prince Edward Road West, Mongkok, Kowloon, Hong Kong

Tel: +852-2886-9318, Fax: +852 2886-9022/9044

**Renesas Electronics Taiwan Co., Ltd.**

7F, No. 363 Fu Shing North Road Taipei, Taiwan

Tel: +886-2-8175-9600, Fax: +886 2-8175-9670

**Renesas Electronics Singapore Pte. Ltd.**

1 harbourFront Avenue, #06-10, Keppel Bay Tower, Singapore 098632

Tel: +65-6213-0200, Fax: +65-6278-8001

**Renesas Electronics Malaysia Sdn.Bhd.**

Unit 906, Block B, Menara Amcorp, Amcorp Trade Centre, No. 18, Jln Persiaran Barat, 46050 Petaling Jaya, Selangor Darul Ehsan, Malaysia

Tel: +60-3-7955-9390, Fax: +60-3-7955-9510

**Renesas Electronics Korea Co., Ltd.**

11F., Samik Lavied' or Bldg., 720-2 Yeoksam-Dong, Kangnam-Ku, Seoul 135-080, Korea

Tel: +82-2-558-3737, Fax: +82-2-558-5141

# RH850/F1x StarterKit V3