

Engineering Corp.

Gordon



Proxagard® System



Model PC1000

Owner's Manual

Installation, Operation and Applications

revision
01/03

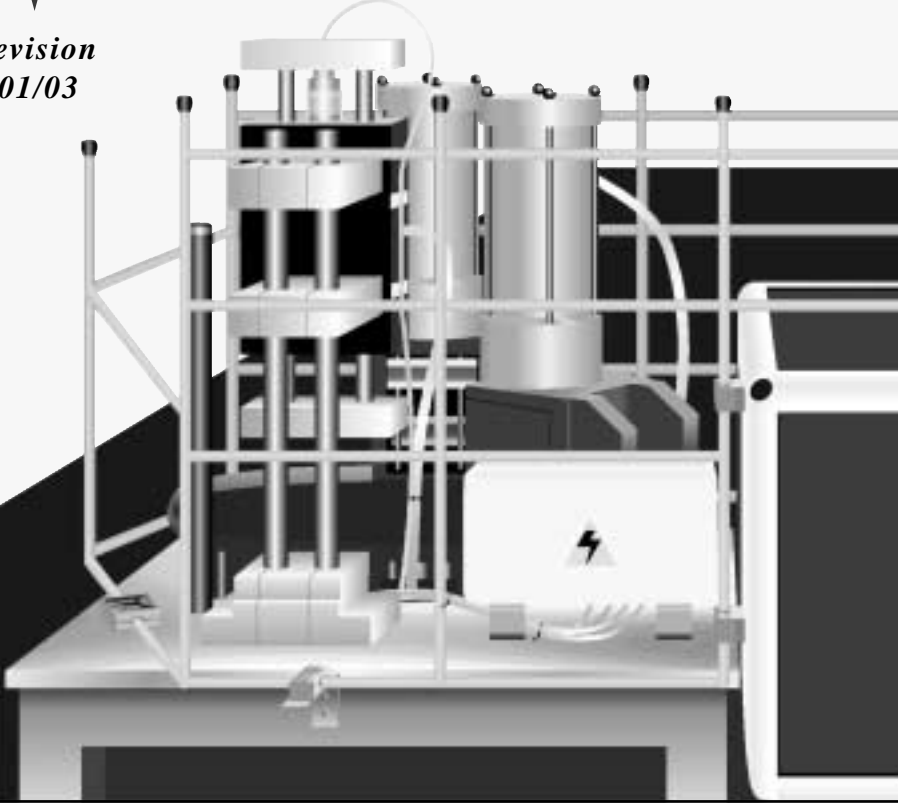

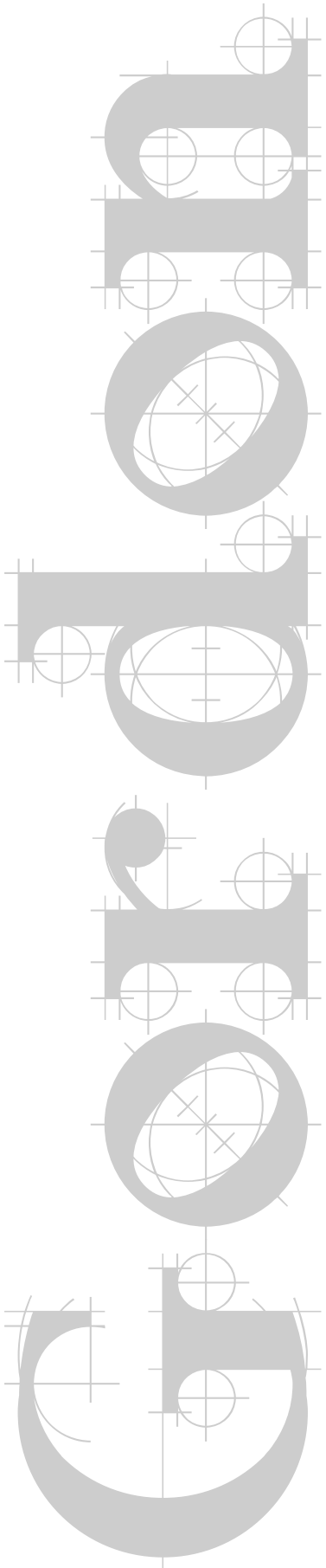

Five-Year Warranty

This product will be repaired or replaced, for five years from the date of purchase, if it fails to perform to published specifications.

The product must be used in accordance with the specified manufacturer's ratings and must not be physically abused.

First Time PC1000 Proxagard® User Installing a New System

- Read page *ix*, which addresses Failsafe Design and other safety factors.
- Read page one.
- Turn to Appendix A on page sixteen and follow the Quick-Check Procedure. When you have familiarized yourself with the basic functioning of the PC1000 Proxagard®, proceed to the next step.
- Read the Antenna Design section, which starts on page two, and use the information to construct a preliminary antenna.
- Turn to the Installation section, which starts on page six, and follow the instructions for installation, operation and testing.

First Time PC1000 Proxagard® User with an Existing Installation

- Read page *ix*, which addresses Failsafe Design and other safety factors.
- Read page one.
- Turn to the Operation section, which starts on page ten, and familiarize yourself with the functions of the PC1000 Proxagard®. Then, follow the instructions for operation and testing.

Experienced PC1000 Proxagard® User Installing a New System

- Read page *ix*, which addresses Failsafe Design and other safety factors.
- Read the Antenna Design section, which starts on page two, and use the information to construct a preliminary antenna.
- Turn to the Installation section, which starts on page six, and follow the instructions for installation, operation and testing.

How to Use this Manual

Experienced PC1000 Proxagard® User with an Existing Installation

- Turn to the Pre-Operation Checklist on page fourteen and follow the directions.

Troubleshooting, Failure Codes and Technical Support

- Turn to Appendix D - page twenty, for troubleshooting procedures and a list of failure codes. If you cannot resolve your problem and the procedure directs you to contact tech support, return to this page and go to the next step.

Contents

i

General Information

| | | |
|----------------------------|------|----------|
| Five-Year Warranty | page | i |
| Contact Information | page | i |

ii - iii

How to Use This Manual

| | | |
|--|------|-----------------|
| First Time User w/install | page | ii |
| First Time User w/existing | page | ii |
| Experienced User w/install | page | ii |
| Experienced User w/existing | page | ii |
| Troubleshooting, Failure Codes and Tech Support | page | ii - iii |

iv - vi

Contents

vii - viii

Specifications

| | | |
|--------------------------|-------|-------------------|
| PC1000 Proxagard® | pages | vii - viii |
| 02A558 Coupler | page | vii |
| Options | page | viii |
| PC1000 Dimensions | page | viii |

ix

Failsafe Design

| | | |
|-------------------------------|------|-----------|
| OSHA Regulations | page | ix |
| General Machine Safety | page | ix |

1

General

Overview page **1**

PC1000 Features page **1**

2 - 5

Antenna Design

Antenna Definition page **2**

Insulators pages **2 - 3**

Sensing Fields pages **2 - 3**

Grounded Shields pages **3 - 4**

Antenna Considerations pages **4 - 5**

Planar Field Antenna page **5**

6 - 9

PC1000 Installation

Guidelines page **6**

02A558 Coupler pages **6 - 7**

Control Unit pages **7 - 8**

Shock Mounts page **7**

Power Wiring page **8**

Wiring Terminals page **8**

Antenna Design Check pages **8 - 9**

Warning Output Wiring page **9**

Stop Output Wiring page **9**

Sample Wiring Diagram page **9**

Contents

10 - 15

PC1000 Operation

| | | |
|----------------------------------|-------|----------------|
| Functions and Indicators | pages | 10 - 11 |
| Control Unit Illustration | page | 10 |
| 02A541 Lock Option | page | 11 |
| Tuning | page | 11 - 12 |
| Quick Reference for Codes | page | 12 |
| Alarm Operation | pages | 12 - 13 |
| Set Alarm | page | 13 |
| Set Warning | page | 13 - 14 |
| Antenna Installation Test | page | 14 |
| Pre-Operation Checklist | page | 14 |
| Operational Test | page | 15 |

16

Appendix A

| | | |
|------------------------------|------|-----------|
| Quick-Check Procedure | page | 16 |
|------------------------------|------|-----------|

16 - 17

Appendix B

| | | |
|------------------------------------|-------|----------------|
| Effective Field Size | page | 17 |
| Sensitivity vs. Load Graphs | pages | 16 - 17 |

18 - 19

Appendix C

| | | |
|--|-------|----------------|
| Planar Field Antenna Construction | pages | 18 - 19 |
|--|-------|----------------|

20 - 21

Appendix D

| | | |
|-----------------------------------|-------|----------------|
| Troubleshooting Procedures | pages | 20 - 21 |
|-----------------------------------|-------|----------------|

PC1000 Specifications

| | |
|-----------------------------------|--|
| Input Voltage | <i>115 or 230 VAC,selectable; single phase; 50/60 Hz; ±15%</i> |
| Power Consumption | <i>8 VA</i> |
| Frequency Range | <i>160 KHz - 400 KHz</i> |
| System Reaction | <i>25 mS welded contact - add 15 mS</i> |
| Self-Check | <i>continuous, independent of machine cycle</i> |
| Stop Output Load Rating | <i>resistive 2.5A, 115 VAC resistive 1.25A, 230 VAC inductive .25A, 115 VAC inductive .125A, 230 VAC</i> |
| Stop Output Contact | <i>normally closed - defined as closed with the unit powered, tuned, not alarmed and no fault</i> |
| Warning Output Load Rating | <i>8A, 115/230 VAC</i> |
| Warning Output Contact | <i>normally open - not to be used as a safety contact</i> |
| Sensitivity Range | <i>depends on antenna design, system setup and coupler hi-lo switch position see below for specifics</i> |

Antenna Size Length or Load

*up to 150 linear feet (45m)
or 750 pF of capacitance*

Alarm Point

*alarm point default is maximum
sensitivity, alarm point can be
changed with access code*

Tuning

*automatic on power-up - tunes to
last tune setting
access code allows manual
initiation of tune function*

Indicators and Controls

keypads: *allow reset, tune, set
alarm and set warning, with
access code*

bargraph: *displays alarm point,
field activity and fault codes*

self-check light: *fault indicator-
when lit, the Stop Output
contacts are open*

run light: *on during normal
operation*

tune light: *on while unit is
tuning*

set alarm light: *on while the
alarm point is being set*

antenna fault light: *indicates
loss of antenna or capacitance*

alarm light: *alarm indicator-
when lit, the Stop Output
contacts are open*

02A558 Coupler

Sensitivity

Range *hi - 750 pF, max.
up to 28 inches (71.1 cm)
radius from antenna
lo - 600 pF, max.
up to 14 inches (35.6 cm)
radius from antenna*

Power Out *1mW maximum*

Cable *10 feet (3m) standard;
longer lengths available*

Physical *epoxy encapsulated
impervious to dirt and oil*

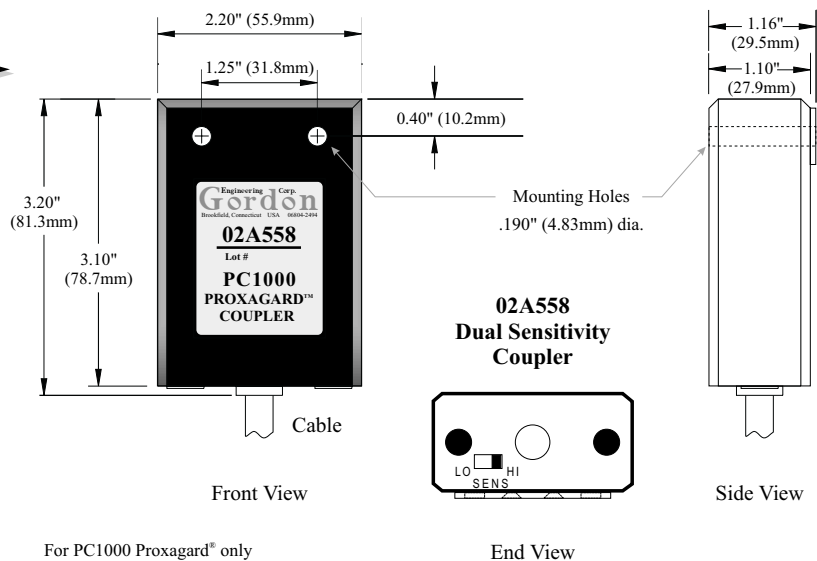

For PC1000 Proxagard® only

End View

PC1000 Specifications



Environment *unaffected by dirt, grease, vibration, etc.*

temperature: 0°F - 130°F
-20°C - 55°C

humidity: 0 - 95% R.H.

PC1000 Enclosure *NEMA 12, industrial plastic
10.2" L x 6.1"W x 4.0"D
(259 mm x 154 mm x 102 mm)*

Mounting *vertical or horizontal - to any bulkhead, chassis or panel
use 03A155 shock mount kit see illustration on page 7
4 mounting holes - clearance holes for .250" (6 mm) bolt
vertical centers - 4.75" apart (120.65 mm)
horizontal centers - 9.49" apart (241.05 mm)*

Shipping Weight *6 lbs. (2.7 Kg)*

Options **02A541 - PC1000 Proxagard® w/ Lock Option**
*requires a key, as well as the access code, to perform the manual tune, set alarm, set warning and fault code reset functions
use this option where an extra level of security is desired - it prevents an unauthorized person from altering the sensitivity settings of the Proxagard®*

Coupler Options **02A558 - Coupler for PC1000 Proxagard®**
*standard cable length - 10' (3m)
lengths up to 50' (15m) are available on request*

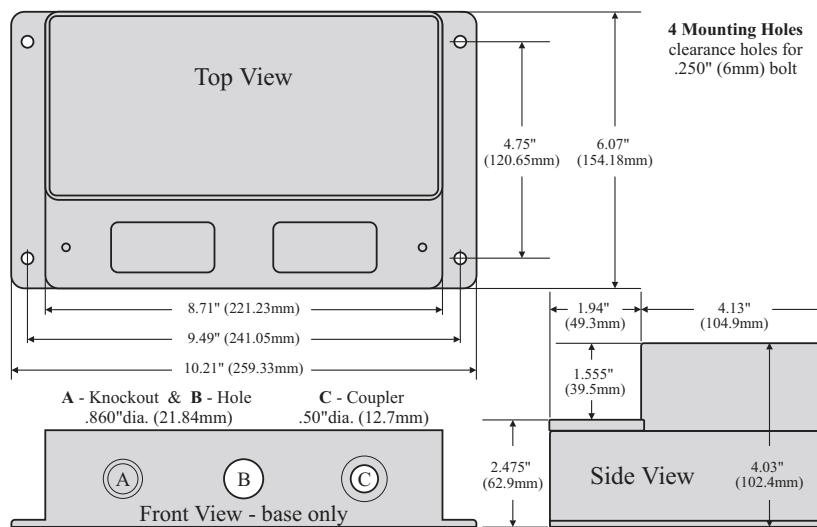

PC1000 Dimensions

This is a dimensional drawing of the PC1000 Proxagard® enclosure. All dimensions are in inches (with metric equivalents in parentheses). For mounting instructions and specifics on shock mounts, please see the Installation section (pages 6-9) of the manual.

Failsafe Design

This equipment is designed to meet the failsafe requirements stated in **OSHA Regulation 1910.217(b)(8)(vi)** as follows:

“Electrical clutch/brake control circuits shall incorporate features to minimize the possibility of unintended stroke in the event of the failure of a control component to function properly, including relays, limits switches, and static output circuits.”

The Model PC1000 Proxagard® incorporates a self-check circuit which operates continuously and is independent of machine cycle. This circuit is designed to detect functional failures, and any failure detected by the self-check will cause the Stop Output to open and the Self Check indicator to light. The cause of the malfunction must be determined and corrected before operation can resume.

OSHA Regulation 1910.217(c)(3)(iii)(b) expressly prohibits use of any presence sensing device as a “tripping device” for any application. The Proxagard® must cause machine stop only. Machine start must be initiated by deliberate action of the operator using a control other than the Proxagard®. This avoids total reliance on any one control for machine safety.

OSHA Regulation 1910.217(c)(3)(iii)(a) prohibits the use of a presence sensing device on machines equipped with full revolution clutches.

You should note that failsafe design is always a matter of degree - the reduction of probability of unsafe failure to a minimum practical level.

In addition to failsafe design, the user must pay strict attention to all factors which affect safety on a hazardous machine; these include, but are not limited to:

1. Operator methods and attitudes
2. Use of complementary guarding
3. Use of reliable failsafe type controls
4. Attention to application-specific hazards or requirements

Please, read this manual thoroughly, before you attempt to install your Proxagard® system, and take particular note of the following sections:

1. Antenna Design section (pgs. 2 - 5)
2. Installation section (pgs. 6 - 9)
3. Operation section (pgs. 10 - 15)

The system should be checked in accordance with the procedures in the Operation section **on a daily basis, or after any changes involving dies, personnel, or the system environment.**

If constant readjustment or retuning is needed, with no apparent change in operating conditions, something is wrong with the installation, the system environment or the system. The cause(s) must be determined and corrected, to insure the safety of the operator.

Presence sensing devices do not protect against objects flying out of the machine (for example, chips, air-ejected parts, broken tools, etc...). If this condition can occur, we strongly recommend using fixed barrier guards rather than, or in addition to, presence sensing devices.

The PC1000 Proxagard® is a capacitive, presence sensing system that is designed for industrial safety applications - specifically, for machine guarding and personnel safety. The Proxagard® system consists of a control unit, a coupler and an application-specific antenna, which is customer designed and built.

The control unit provides power to all system components, monitors functionality of the system and operates the control and safety relays.

The coupler, which is electrically (and may be mechanically) connected to the antenna, generates a low-level electromagnetic field that surrounds the antenna. Any intrusion into this surrounding area by a person, a machine or metal parts causes a change in this electromagnetic field. The coupler translates this change into a change in output voltage, which is sent to the control unit via the coupler cable. When the coupler output voltage exceeds the alarm point, the control relay in the Stop Output circuit opens. This relay can be used to initiate machine-stop, apply a brake, or to effect some other desired control function.

The PC1000 Proxagard® is a microprocessor-based system that features automatic tuning, which can be manually initiated; automatic and manual alarm point (sensitivity) adjustments; a separate, settable warning output; relay monitoring and protection circuitry, continuous system self-check, and the ability to tune up to 150 linear feet (45m) of antenna or 750 pF of capacitive load.

On initial power-up, the Proxagard® tunes automatically with the system sensitivity defaulted to maximum. The keypad allows the authorized user to retune and alter the alarm point or warning settings; these new settings are stored in memory and become the defaults for subsequent power-ups. An access code prevents unauthorized keypad entry, and a lock option is available, which requires the authorized user to have a key and the access code to alter these settings. The alarm point and field activity are displayed on a bargraph during normal operation.

Overview

The antenna design is left to the customer, because the configuration possibilities are infinite and the design of the antenna requires specific knowledge of the application. Most antennas are constructed of materials that can be purchased at an electrical or plumbing supply, and guidelines for design and construction are given in the Antenna Design section (pgs. 2-5).

If you find the information we've provided in this manual does not adequately address your design questions, our engineers are available to discuss general design techniques or to consult with you on the specifics of your application.

PC1000 Features

A separate, adjustable Warning Output provides a means to alert personnel to the fact that they are in the sensing field - this feature can be used to eliminate unintended machine stops.

The Stop Output is comprised of a control and a safety relay. The safety relay's contacts are wired in series with those of the control relay, and the safety relay opens the Stop Output if a control relay contact welds.

The self-check circuit, which monitors the control circuitry, operates continuously and is independent of machine cycle. In the event of a self-check fault, the Stop Output opens and a fault code is displayed on the bargraph.

The system can support an antenna up to 150 feet (45m) in length, with no constraints on the shape of the antenna; however, it must be rigid and isolated from ground. Please, see the Antenna Design section (pgs. 2-5).

Antenna Design

Antenna Definition

A rigid conductor, mounted on insulators and placed around or adjacent to an area that requires guarding. Copper tubing or thin wall conduit are the most commonly used materials. The antenna may be, but is not required to be, a closed loop. The antenna must guard the point of operation, all pinch points and must not create new pinch points.

Mounting Distance

OSHA Regulation 1910.217(c)(3)(iii)(e) defines the minimum safety distance for mounting an antenna by the formula:

$$Ds = K(Ts + Tp)$$

Where:

- Ds** = Minimum safety distance between antenna and point of operation
- K** = 63 inches/second (1.6 m/s)
- Ts** = Total stopping time of the electromechanical system, in seconds
- Tp** = Total response time of the Proxagard® (.025 seconds)

Example: If the mechanical stop time of a machine is 0.3 seconds, the Minimum Safety Distance (from the point of operation to where you may mount the PC1000 Proxagard® antenna) is 20.475" [20.475" = (63 inches/s)(0.3s + .025s)].

Insulators

Insulators, which support the antenna, must be rigid and nonporous. PVC, teflon, delrin and nylon are some commonly used insulating materials. Insulators must not be made from materials that contain conductive elements (e.g., Carbon, an element commonly used in the manufacture of black colorants, is conductive).

Sensing Field

The coupler generates an electromagnetic field around the antenna elements. This field is sensitive to intrusion by personnel, machinery and metal parts. Changes in the field are detected by the Proxagard® and acted upon when the preset alarm levels are exceeded. If a single antenna element is not sufficient to guard the area, two antenna elements may be placed parallel to one another 12" to 24" apart, which creates a strengthened field between them.

Effective Field Size
at
Minimum and Maximum Sensitivity

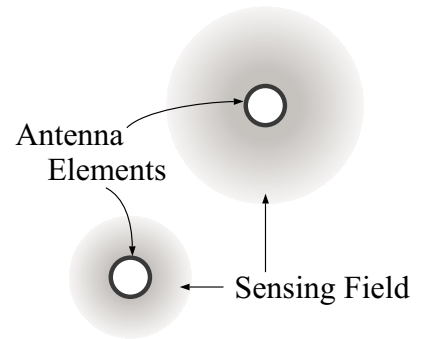

Insulators

These are dimensional drawings of PVC, insulating standoffs that are available from Gordon.

Use these part numbers to order from us or use the drawings to manufacture your own - any rigid, insulating material that can withstand your manufacturing environment may be used.

Threaded Standoff # 02A057

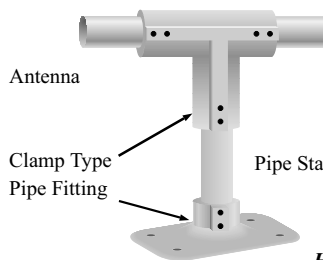
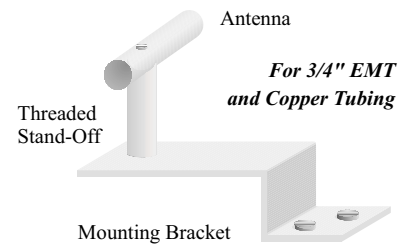
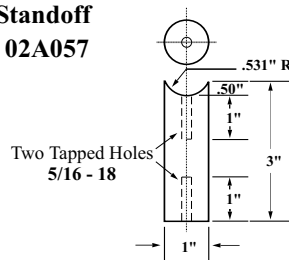

Pipe Standoffs 6" # 02A024

4" # 02A061

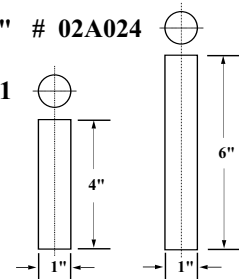

For 3/4" Pipe or Heavy Wall Conduit

When the optimum design and alarm point settings are achieved, the field between the elements is oblong, with no “holes” and very little peripheral sensitivity. At the maximum alarm setting the field may become bulbous and extend more than a desirable distance from the antenna. At the minimum alarm setting “holes” can develop in the protective field. If the unit’s alarm setting is at maximum and a “hole” still exists in the protective field, the antenna elements must be moved closer together or an additional element must be added.

Optimum Design for Parallel Elements

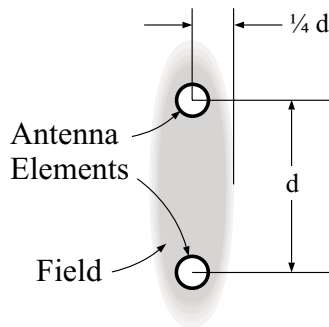

Grounded Shields

Another way to shape the sensing field is to construct grounded shields adjacent to the sections of the antenna where an attenuation of sensitivity is required.

Shields can be made of any rigid, conductive material (round or flat stock) that is electrically

Antenna Design

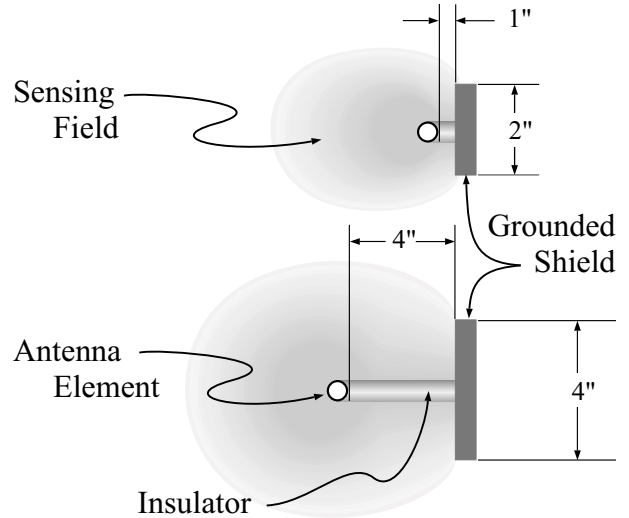

isolated from the antenna and is grounded to the control unit’s electrical ground - round stock, at the same distance, provides less field attenuation and antenna loading.

Grounded shields can be employed to shape the sensing field away from an operator’s workstation or the travel path of a machine component. The field will not extend past the shield, and will be diminished on the antenna side relative to the size and proximity of the shield. The closer the shield is to the antenna element the greater the amount of attenuation.

Pipe Clamp # 02A050

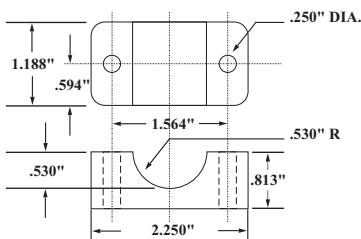

Pipe Clamp

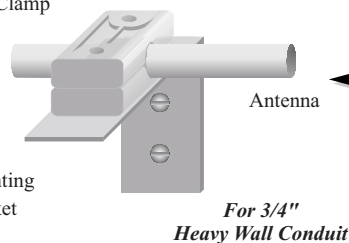

Insulators

These are dimensional drawings of insulating clamps that are available from Gordon. Use these part numbers to order from us or you may purchase clamps directly from a plumbing supply - just make sure the clamps you buy are the insulating type.

Pipe Clamp

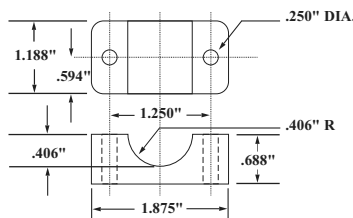
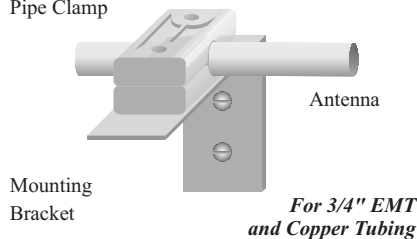

Pipe Clamp # 02A080

Antenna Design

This principle of proximity to ground and attenuation of field sensitivity is also applicable to any metal machine parts that encroach upon the sensing field. It is possible for the attenuation to be severe enough to open “holes” in the protective field. One way to counteract this effect is to place an additional antenna element to reinforce the field at such a location. Whenever possible, the preferred solution is to shape the antenna away from ground by at least 4", as ground

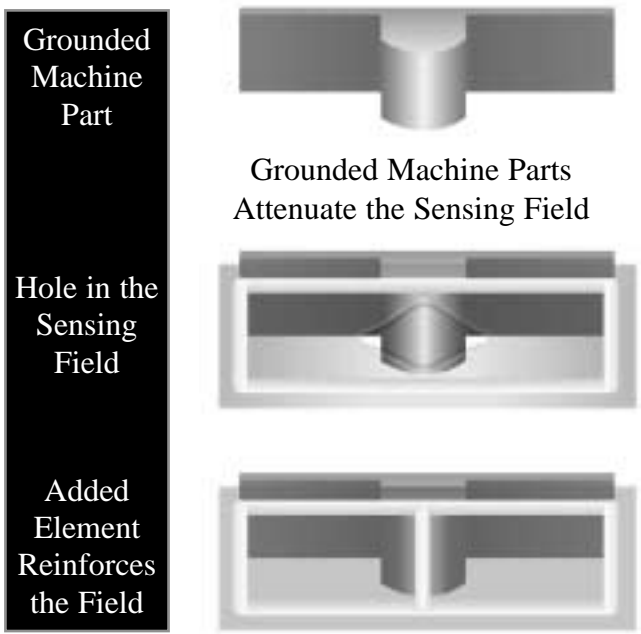

proximity decreases overall system sensitivity and decreases the potential length of antenna elements that can be tuned by the unit.

Safety Note:

Where grounded shields are used, physical guards may be needed to insure operators can't reach around the shields to pinch points.

It is extremely important that the shield and the antenna be rigidly mounted and unable to move in relation to each other or the machine.

Failure to observe these design rules can cause a hazardous condition, nuisance alarms or both.

Antenna / Machine Considerations

Machine Motion - The antenna should be designed so that all machine parts stay at a constant distance from the antenna. This requirement is satisfied when all antenna sections are parallel to machine motion. If it is not possible to comply with this requirement, you may have to install grounded shields between the part and the antenna to mask the machine's motion, or move the affected section of antenna farther away from the machine part.

Ground Proximity - The closer an antenna is to ground, the more its field will be attenuated in that area. To compensate for any holes in the field, add either vertical or horizontal antenna sections.

Typical Antenna

This is an illustration of an antenna that wraps around an automatic assembly machine - the type of application that the Proxagard® is best suited to address. This illustration is based on a photograph of an actual installation.

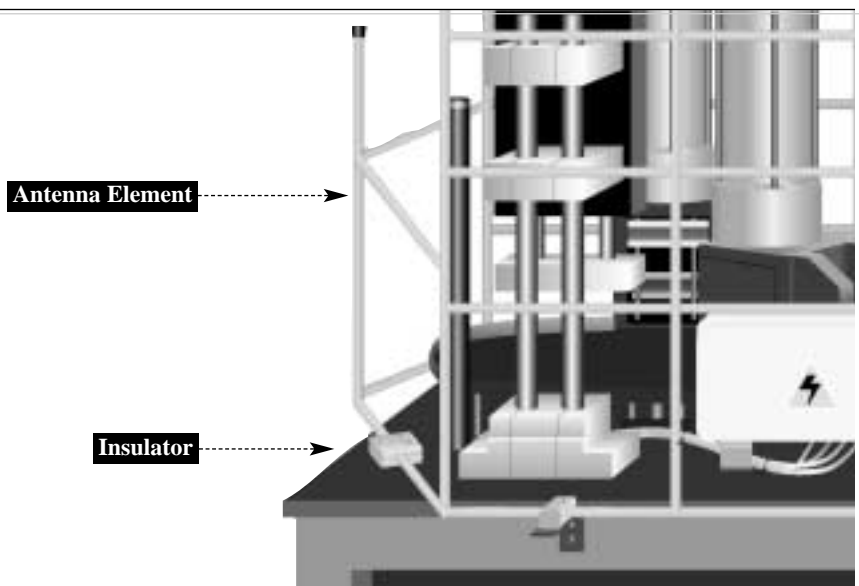

Antenna Design

Chutes or Conveyors - If the presence of materials on a chute or conveyor influences the field, grounded shields may have to be installed between the materials and the antenna, to prevent nuisance alarms or tuning failures.

New Pinch Points - The antenna must be kept an absolute minimum of 2" from any object, to insure that new pinch points (where an operator's hand could be lodged) are not created between the object and the antenna.

Typical Installation (for automatic assembly machines) - Install the first antenna loop 4" above the base of the machine. The sensing field extends to the base of the machine and the 4" clearance insures against new pinch point creation. Install a second antenna loop 12-24" above the first and electrically connect it to the first loop. A third or fourth loop may be added, if required.

Field Uniformity - Test the sensing field thoroughly, and add antenna sections in any areas where holes in the sensing field are evident.

Construction Tip

Initially, you should slip fit antenna sections together, using whatever connectors or fittings are appropriate for the material you have chosen to use. Don't solder or weld the joints until you have thoroughly tested your design, as specified in the Installation and Operation sections.

Checklist

- The antenna element and shields may be constructed of any rigid, conductive material.
- The antenna must be insulated from ground.
- The antenna should be mounted as far as possible from ground - use 4" as a guideline, wherever possible.
- Ideally, operator intrusion should be the only influence on the the sensing field - grounded shields can be used to minimize other influences (e.g., machine motion).
- The antenna and any shields must be rigidly mounted to prevent movement relative to each other, the machine and ground.
- Test your antenna design, using the procedures in the Operation section of the manual (pgs. 10 - 15).

Checklist

Front View

Side View

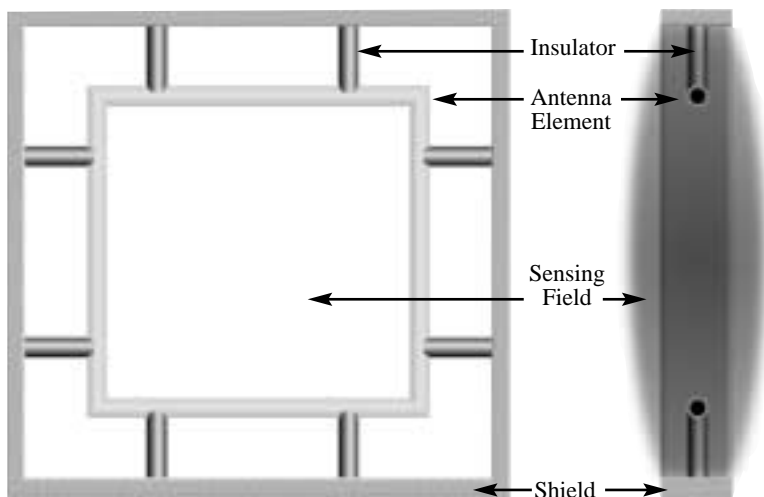

Planar Field Antenna

Ideally suited to single point of entry applications, where the machine controls and operator's station are close to the antenna - you get a relatively flat zone of protection (with very little influence from adjacent machine or operator motion) and crosstalk immunity, where more than one Proxagard® antennas are used.

See Appendix C for details.

Installation

Guidelines

The following is a list of installation guidelines that **must** be followed to insure safe and proper operation. Please, examine them thoroughly.

Note: Make sure you read and understand the section on failsafe operation (page *ix*) before you begin to install your PC1000 Proxagard® system.

Antenna Design - Insure that your antenna is designed and constructed according to the instructions in the Antenna Design section (pgs. 2-5).

Antenna Installation - Insure your antenna and grounded shields (if any) do not vibrate excessively or change position relative to each other or ground as a result of normal machine operation.

Antenna Isolation - Make sure that no part of your antenna is grounded, nor can become inadvertently grounded, as a result of normal machine operation.

Machine Motion - Machine parts should not have more than two bargraph segments of influence on the sensing field during normal operation.

Control Unit Placement - The unit should be placed far enough away from the antenna to insure against user influence on the field during tuning.

Coupler/Antenna Connection - Make sure the coupler contact plate has a solid, electrical connection to the antenna - sanding of the antenna surface in the area of contact is required.

Coupler Cable - The coupler cable must be secured (out of the sensing field) in a way that insures against physical damage and movement of the cable relative to ground and the sensing field.

Control Unit Electrical Ground - The control unit **must have a solid ground connection** to the machine control ground buss.

Stop Output Wiring - The Proxagard® Stop Output should be wired into the machine control stop circuit in such a way that the Proxagard® will **cause machine-stop when it alarms**. It must **only cause machine-stop** - any restart of the machine must be the result of a deliberate action by the operator, using a control other than the Proxagard®. Extreme care must be taken to insure that machine-start does not occur automatically when the Proxagard® Stop Output resets. Finally, the machine **must not be able to operate in any mode while the Proxagard® is alarmed**.

02A558 Coupler

The 02A558 Coupler, and its predecessor the 02A511 Coupler, are the **only** models that can be used with the PC1000 Proxagard®. Please, see Specifications (page *vii*) for dimensions and data.

Coupler Installation

Direct connection of the coupler to the antenna, with two machine screws, is the recommended method of installation.

Alternately, connect the coupler indirectly to the antenna with a short length of insulated wire or RG62/U coaxial cable - length is limited to 8 feet (2.4m), and will result in a reduction of as much as 20 feet (6.1m) of achievable antenna length.

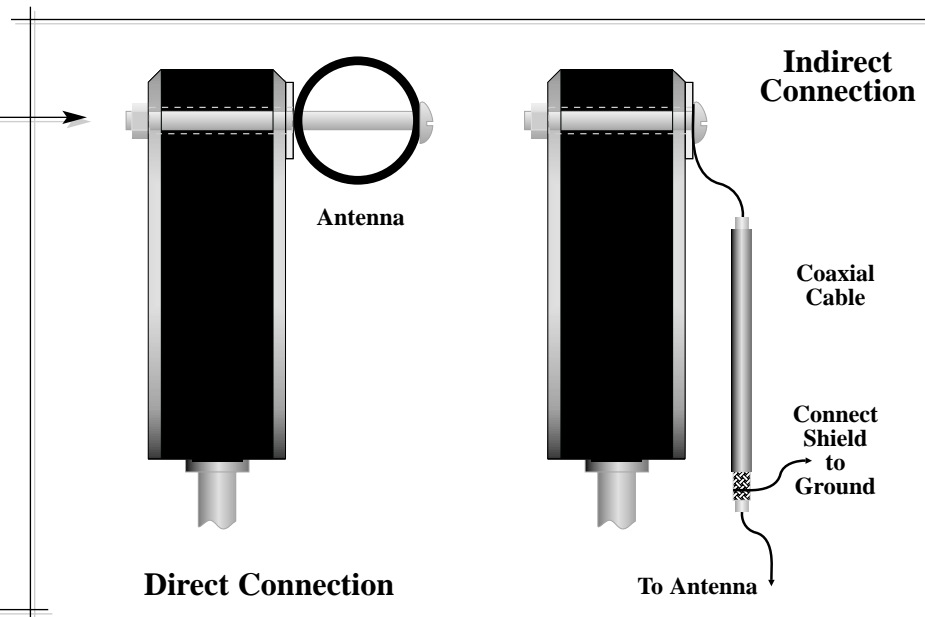

The Proxagard® is normally shipped with the coupler cable connected to terminals eight (8) through eleven (11) inside the control unit - the wire colors are printed on the unit, below the terminals. The purple and black wires from the coupler are crimped together to a single spade lug, which goes to the terminal labeled “BLK”. The other lugs each have a single wire and are attached to their corresponding terminals.

The coupler may be installed anywhere along an active antenna element; however, as a practical matter, we recommend you choose the location on the antenna that is closest to where you intend to mount the Proxagard® control unit.

Mounting Holes - The coupler has two through holes, which are .190" (4.8 mm) in diameter and spaced 1.25" (31.8 mm) apart. These are the proper clearance holes for the #10 machine screws provided with the unit. Drill two corresponding holes through your antenna element where you wish to locate the coupler.

Installation

Surface Preparation - Use sandpaper to remove any paint, coating or oxidation from the surface of the antenna element that contacts the coupler’s contact plate.

Mounting Methods - The coupler may be mounted directly or indirectly, as illustrated at the bottom of page 6, but we recommend that you use the direct method whenever possible.

Coupler Cable - Dress the coupler cable so that it exits the coupler perpendicular to the antenna. The cable must not be routed along or attached to the antenna element.

Control Unit

Mounting Distance - The unit must be far enough away from the antenna to insure that the person who is authorized to make system adjustments is not affecting the sensing field while the adjustments are being made.

Wiring Terminals for PC1000 Proxagard®

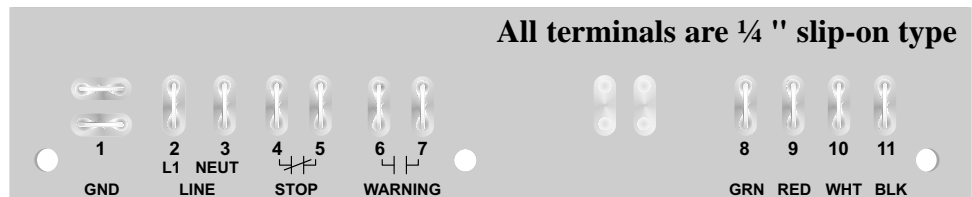

03A155 SHOCK MOUNT KIT

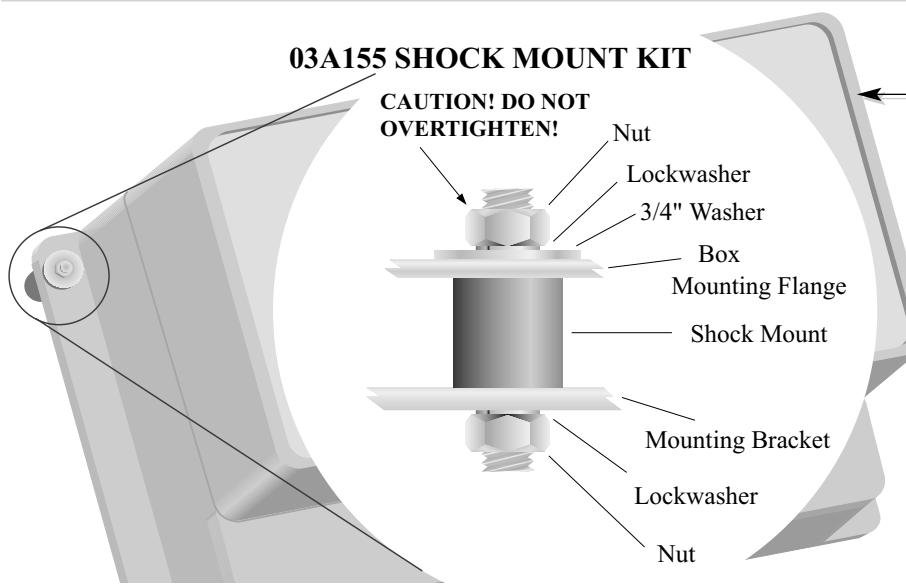

03A155 - Shock Mount Kit

Installation

Control Unit

Location - Our recommendation is that you locate the unit near the operator's station, in a manner that allows the operator full view of the unit's Alarm Light. If there is such a location that is also near the machine control, take advantage of it - you can substantially reduce your wiring requirements, if you do.

Orientation - The control unit may be mounted horizontally (to a table or bench) or vertically (to a bulkhead or panel). For detailed dimensions, please refer to PC1000 Specifications (page *viii*).

Vibration - **Do not mount the control unit to any surface that is subject to excessive vibration.** We strongly recommend that you use the 03A155 shock mount kit (see page 7) provided with your Proxagard® system, even in low or no vibration environments.

Power Wiring

Access - The control unit has one hole and one knockout, both for ½" (12.7 mm) electrical fittings, either of which can be used to route power and machine control wiring. For detailed dimensional information, please refer to PC1000 Specifications (page *viii*).

Note: To maintain Type 12 environmental integrity, use a UL approved Type 12, 12K, 13 or equivalent fitting.

Voltage Selection - Move the selector switch to the proper position for the voltage you intend to supply to the unit.

Voltage Requirements - The control unit must be supplied with 115 or 230 VAC, 50/60 Hz, single phase power.

Power Connection - Find a source of power that is after the main disconnect for the machine, but before any stop switch. Connect L1 and Neutral to terminals 2 and 3, respectively. The current draw of the unit is 0.08 amperes - consult local electrical codes to determine your wire size requirements. In most cases #14 AWG, fed by a 15A circuit breaker or fuse, will meet or exceed the code requirements.

Ground Connection - **Terminal 1 must be connected to machine ground** - this is the ground reference for the entire system and is essential for proper operation.

Antenna Design/Construction Check

Do not connect the Stop Output to the machine controls until your antenna design is thoroughly tested. To conduct this test, you will need to turn to the Operation section (pg. 10) and carefully follow all the procedures. All instances of machine-stop that are indicated in the instructions should produce an alarm indication from the control unit, but not stop the machine.

Note: The solderless wire connectors supplied are Hollingsworth #XS09723SN. The proper crimping tool to be used is Hollingsworth #H43.

Power/Relay Wiring

This is an illustration of the power and relay terminals and the power selection slide switch in the control unit of the PC1000. The two horizontal terminals (labeled 1) are connected to each other electrically - when ground is connected to one, it's present at the other.

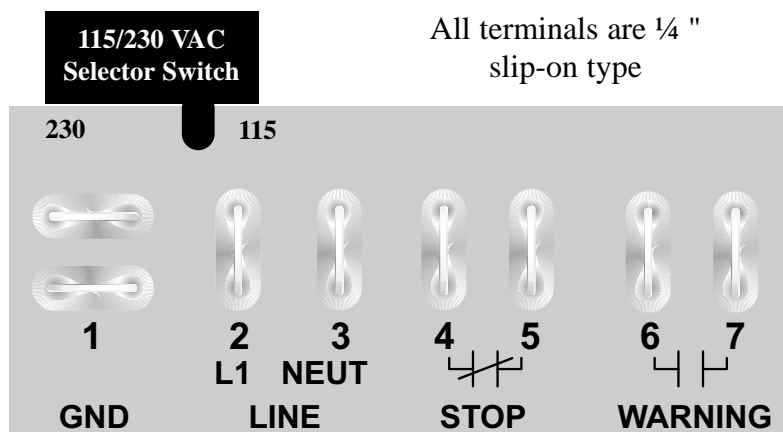

Installation

Note: Everyone in the area should be warned of the potentially hazardous conditions that exist during the installation process - you must run the machine, in order to test the antenna, but the Stop Output is not wired to stop the machine. Extreme care should be taken to insure the safety of those involved in the installation process and any others who may enter the area during this time.

Now, turn to the Operation section (pg. 10), follow all the procedures carefully, and, when all the requirements are fulfilled, return to this point and complete the wiring of the output relays.

Warning Output Wiring

General - The Warning Output is not to be used for machine-stop. It is designed to provide the user with an independent relay contact, which can be used to control a visual or an audible warning, that indicates an intrusion into the sensing field. The warning level is independently settable and provides pre-alarm indication.

Output Characteristics - The Warning Output functions as a normally open relay contact - open when the Proxagard® system is powered, tuned, not in an alarmed state and the warning set-point has not been exceeded.

Relay Connection - Wire the warning device to terminals 6 and 7.

Stop Output Wiring

General - All machine control wiring must be done by qualified personnel, who are familiar with the machine control schematic, the functionality of the Proxagard® system and all regulatory requirements for machine guarding devices. Before wiring the Stop Output, insure compliance with the Guidelines at the beginning of the Installation section (page 6) and the following requirements.

Output Requirements - The current through the Stop Output must not exceed the values stated in the PC1000 Specifications (page vii). If you have an application that requires a greater current capacity, a slave relay, wired in a failsafe manner, must be used.

Output Characteristics - The Stop Output functions as a **normally closed relay contact**. We define normally closed as, **closed when the Proxagard® system is powered, tuned and not in an alarmed state.**

Access - You may bring the wires for the Stop Output into the control unit through the same conduit as the power connections, or route them through the alternate opening - the choice is yours.

Relay Connection - Connect wires to terminals 4 and 5.

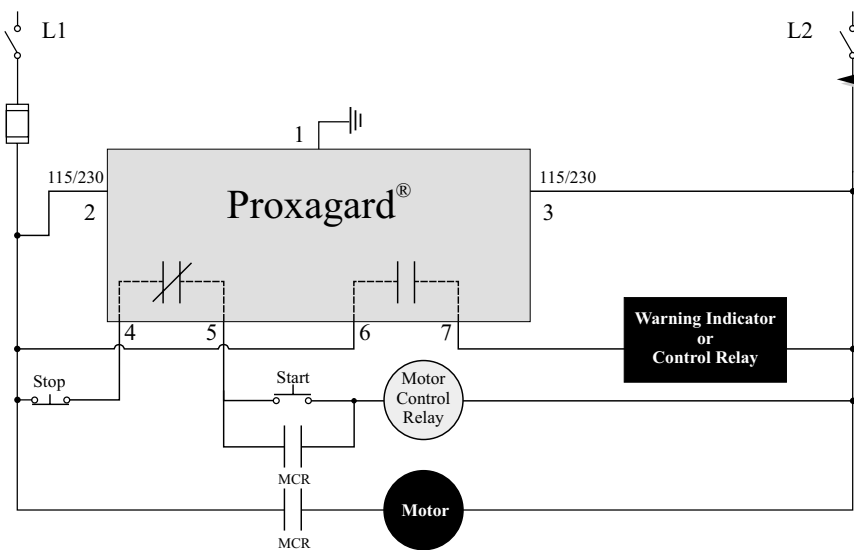

Sample Wiring Diagram

We offer this simplified wiring diagram as an example of the logic that must be applied to the Proxagard®/machine control interface wiring.

The Stop Output **must not** be wired directly to the Motor Control Relay coil - this would make the unit act as a “tripping device”, which is unsafe and illegal.

Operation

If you are familiar with Proxagard® system operation, turn to pages 14 and 15, where you will find system test information and concise instructions for daily operation.

Introduction to Functions and Indicators

Operation Indicators - There are five operation indicators, arranged vertically down the left-hand side of the control panel; they are (from top to bottom) Self Check, Run, Tune, Set Alarm and Antenna Fault.

Self Check - The Self Check circuit operates continuously and is independent of machine cycle. If it detects a failure, the Self Check indicator lights and the Stop Output opens. **This function overrides any other indicated mode.**

Run - The Run indicator is lit, except when the unit is in the Tune mode or the Set Alarm mode of operation. When the unit goes into alarm, the Alarm Light lights and the Stop Output opens. This is normal operation in Run mode and the Run indicator remains lit.

Tune - The Tune indicator and the Alarm Light come on when the unit enters the Tune mode - to prevent machine operation during the tuning process, the Stop Output opens. Once properly tuned, the unit enters Run mode, the Alarm Light goes out and the Stop Output closes.

Set Alarm - The Set Alarm indicator and the Alarm Light come on when the unit enters the Set Alarm mode - the Stop Output opens to prevent machine operation during the process of setting the alarm point. Once set, the unit enters Run mode, the Alarm Light goes out and the Stop Output closes.

In the Set Warning mode, the Run and Set Alarm indicators are both lit - this represents the only instance where these two indicators should be lit simultaneously.

Antenna Fault - The Antenna Fault indicator lights and the Stop Output opens, when the Proxagard® control unit detects a negative change in the antenna load. This is the opposite of intrusion into the field and may be caused by loss of an antenna section; by movement of a machine part, in a direction away from the antenna or by removal of an object from the sensing field that was present during the tuning process.

LED Bargraph Display - The bargraph is a multi-purpose display. Its primary function is to provide a visual indication of field intrusion, in relation to the alarm point. The individual bargraph segments also serve as the alarm point indicator for the Set Alarm function. In Run mode, the one segment that always remains lit indicates the alarm point setting.

PC1000 Control Unit

The PC1000 Proxagard® has five operation indicators, arranged vertically down the left-hand side; an LED bargraph display, for monitoring field activity; three function keypads, for setup and reset functions; and an alarm light, which indicates the state of the Stop Output.

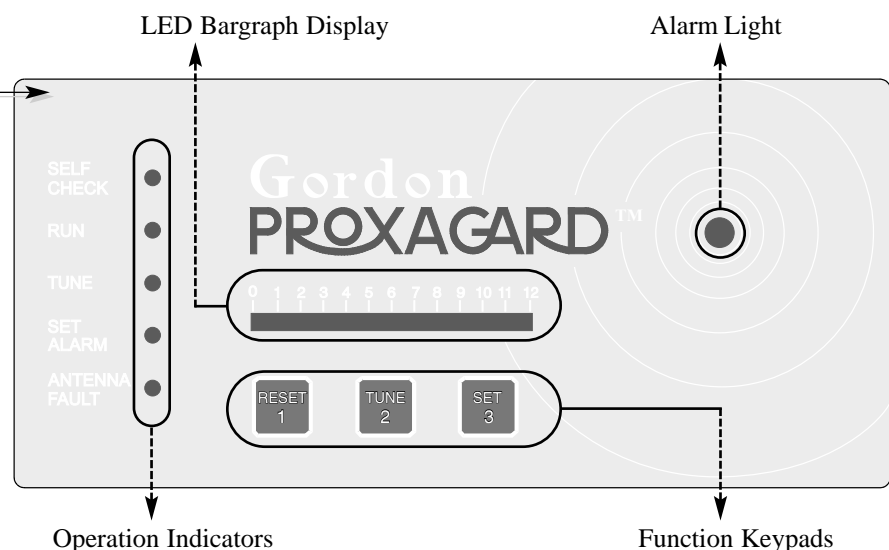

Operation

Tuning

General - Tuning is the process that optimizes the sensing field of a specific antenna, based upon antenna system attributes such as size, shape, material composition, ground proximity and the position of the Hi-Lo switch on the coupler. The machine **must** be stopped and the sensing field clear of personnel and movable objects, whenever the system is tuning.

When the Tune indicator is lit the unit is in alarm, the Stop Output is open and the system is in the process of tuning. During this process, the bargraph segments light and go out, progressively from left to right, to indicate the microprocessor's search for the optimum field. Once the unit tunes successfully, a single bargraph segment lights to indicate the alarm point setting. The unit enters Run mode, the Alarm Light goes out and the Stop Output closes.

A failed tuning results in every segment of the bargraph being lit, while the unit remains in Tune mode. This condition usually indicates an underlying problem (e.g., antenna design or component failure) or, if it happens at power-up, a significant change in the system environment since the last tuning procedure - the cause must be determined and rectified.

Alarm Light - The Alarm Light lights and the Stop Output opens whenever the unit goes into alarm - intrusion into the sensing field, initiation of the Tune or Set Alarm mode or an Antenna Fault can all be causes. Once the cause is cleared, the unit returns to Run mode, the Stop Output closes and the Alarm Light goes out.

Function Keypads - There are three function keypads, arranged horizontally beneath the bargraph display; they are (from left to right) Reset, Tune and Set.

Reset - The Reset keypad (1) will reset an Antenna Fault condition, once the underlying cause of the fault has been rectified. It is also used, in conjunction with the Primary Access Code, to reset various Self Check Faults.

Tune - The Tune keypad (2) is used, in conjunction with the Primary Access Code, to initiate the manual tuning process.

Set - The Set keypad (3) is used, in conjunction with the Primary Access Code, to set the alarm point and, in conjunction with the Secondary Access Code, to set the warning point.

02A541 Lock Option - Adds an additional level of security - it requires the authorized user to have a key, as well as the access codes, to access the Tune, Set Alarm and Set Warning modes of operation and to reset a Tuning or Self Check Fault. Operation is otherwise identical.

Rounded Edge



Mounting Flange

02A541 Lock Option

The key must be in the Setup position for the Tune and Set keypads to function. In this position, the Set Alarm and Tune indicators light and the Run light turns off. The unit's Alarm Light turns on and the Stop Output opens.

After the desired functions have been executed, return the key to the Run position and remove.

Push the Reset key to insure the unit comes out of alarm.

Operation

Automatic Tuning - On initial power-up, the unit tunes the antenna and defaults the alarm point setting to the maximum achievable level for the system - this is always segment four (4) on the bargraph. On subsequent power-ups, the system attempts to restore itself to the tuning and alarm point setting present at power-down. If there is sufficient change in the antenna or the environment, the system fails to tune (all bargraph segments lit) and a manually initiated tuning is required; otherwise, the system tunes and displays a single lit segment between four (4) and ten (10), depending on the previous alarm point setting.

Manually Initiated Tuning - In order to initiate the tuning process manually, an authorized user must enter the following code on the keypad: **3232** - which is the Primary Access Code (323), followed by the Tune key (2).

The unit goes through the tuning process, as previously described, and, if the system tunes properly, the unit reverts to the Run mode with the alarm point defaulted to maximum. To adjust the alarm point, see the Set Alarm procedure.

Alarm Operation

The Stop Output is controlled by two alarm thresholds - one positive and one negative. The positive threshold is indicated by the bargraph

segment that is designated as the alarm point setting, and can be altered by an authorized user.

The negative threshold is fixed, and exceeding it is referred to as an Antenna Fault alarm - there is no bargraph indicator for this threshold, but the Antenna Fault indicator lights whenever this threshold is exceeded.

As an object approaches the antenna, the bargraph segments light from left to right, and, when the bargraph segment that is set as the alarm point indicator is reached, the Alarm Light lights and the Stop Output opens. If the object moves away from the antenna, the bargraph segments go out from right to left - at the point where the alarm point setting is no longer exceeded, the Alarm Light goes out and the Stop Output closes.

If an object that was in the sensing field during the tuning process moves away from the antenna, its movement is felt as a loss of apparent antenna load. If the movement is great enough, the negative alarm threshold is exceeded and an **Antenna Fault** alarm occurs, the Alarm Light lights and the Stop Output opens. The most common causes of this type of alarm are machine motion and movable containers in the sensing field (see the Antenna Design section pgs. 2-5).

You should note that **this type of alarm is not self-resetting**, because it can be the result of an unsafe condition, such as the loss of an antenna section.

PC1000 Function Codes

This is a quick reference of function and reset codes - for detailed explanations of these functions, refer to the function's corresponding subsection.

The reset for a tuning fault is the Tune Function code - if the unit will not retune, there is an underlying problem.

| Functions | Codes |
|-------------------------|------------------------------------|
| Tune | 3232 |
| Set Alarm | 3233 then 3 (to set) |
| Set Warning | 3213 then 3 (to set) |
| Resets | |
| Antenna Fault | 1 |
| Self Check Fault | 3231 |

To reset an Antenna Fault alarm, the system must be restored to the state it was in at the time of the last tuning procedure. You must insure the electrical and mechanical integrity of the antenna, restore the “at rest” position of any machine parts that influence the sensing field and the position of any movable objects that were in the sensing field when the system was last tuned.

Press the Reset key (1). If the unit does not come out of alarm, recheck your antenna. If there is no evidence of loose connections or missing antenna sections, it is likely that your antenna design is too heavily influenced by machine motion. Retune and observe the bargraph, while the machine runs. If the machine goes into Antenna Fault again or you see more than two segments of bargraph activity, you will need to reshape the antenna or add shielding.

Once the antenna design is optimized, retune the system and initiate the Set Alarm procedure.

Set Alarm

The Set Alarm procedure allows an authorized user to set the positive alarm threshold anywhere between the maximum alarm point setting (bargraph segment four [4] remains lit) and the minimum alarm point setting (bargraph segment ten [10] remains lit).

The range of distances at which the unit will alarm is dependent upon antenna geometry, size, material composition and the setting of the Hi-Lo switch on the coupler. In general, if the coupler Hi-Lo switch is in the Hi position and the desired alarm point setting is nine (9) or ten (10), move the switch to the Lo position. There are graphical representations of effective field size versus antenna length in Appendix B (pages 16-17).

The **Set Alarm procedure** often requires two people - one to operate the control and another to simulate the machine operator.

To initiate the procedure, you must enter the following code on the keypad: **3233** - which is the Primary Access Code (323), followed by the Set key (3).

The unit's Run indicator goes out, the Set Alarm indicator and the Alarm Light both come

on and the Stop Output opens. Instruct the person simulating the operator to extend a fingertip toward a pinch point. Observe the influence on the bargraph display. When the desired alarm point setting is reached, **press the Set Key (3)**. The unit returns to Run mode, but remains in alarm until the operator's finger moves away from the antenna. Make sure the unit comes out of alarm, then, have the operator repeat the motion, to check the alarm point.

At no time should the alarm point be set low enough to create a “hole” (area of no detection) in any portion of the sensing field. There must not be any way to access any pinch point, without a resultant alarm and machine-stop.

Set Warning

The warning alarm point always defaults to the same point as the alarm point setting. After the Tuning function, this is represented by bargraph segment four (4), and, after the Set Alarm procedure, it may be represented by any segment from four (4) to ten (10). The Set Warning procedure allows an authorized user to set the warning threshold to some pre-alarm level between bargraph segment three (3) and the selected alarm point setting - Note: There is no warning alarm point indicator. This procedure **must be performed after the Tune and/or Set Alarm functions**, unless you intend to use the default alarm point setting as the warning alarm point.

The **Set Warning procedure** often requires two people - one to operate the control and another to simulate the machine operator.

To initiate the procedure, you must enter the following code on the keypad: **3213** - which is the Secondary Access Code (321), followed by the Set key (3).

The unit's Run indicator stays lit and the Set Alarm indicator comes on. Instruct the person simulating the operator to extend a fingertip toward a pinch point. Observe the influence on the bargraph display. **Press the Set Key (3)**, when the desired warning alarm point is reached.

Operation

The Set Alarm indicator goes out. The unit stays in warning alarm until the operator's finger moves away from the antenna. Make sure the unit comes out of warning alarm, then, have the operator repeat the motion, to check the warning alarm point.

Antenna Installation Test

Apply power to the system. Initiate a manual tuning function and insure that the alarm point setting is defaulted to its maximum sensitivity (bargraph segment four is lit). Then, check the alarm operation of the Proxagard®, to insure that the unit alarms properly.

Perform the Set Alarm procedure - set the alarm point to the lowest level possible that still insures alarm when access to any pinch point is attempted. It may be necessary, at this point, to move, reshape or add sections to the existing antenna, in order to comply with this requirement. It's possible for "holes" in the protective field to exist, even at maximum sensitivity, if the antenna is too close to ground or not properly designed for the application. Focus on one area at a time, adjust the design and test for "holes". When all pinch points are positively protected, at the alarm point setting that will be used under normal operating conditions, it's time to check for influence of machine motion on the antenna.

Run the machine through its normal operating cycle and observe the bargraph for evidence of influence on the sensing field. If the system goes into alarm or you observe excessive influence, you will need to shield the machine parts that are responsible or reshape the antenna in this area. You may need to run the machine slowly, in order to determine the sources of influence. Once you have identified an offending component, take action to rectify the problem (see pages 3-5 of the Antenna Design section). Continue with this process until as much influence as is practical is eliminated.

Now, have someone simulate the operator - insure that the operator's location or movements don't cause undesired alarms. You may have to construct shields to mask the operator's presence.

Test the antenna configuration, whether you have modified it or not, to insure that all pinch points are guarded. Attempt to defeat the guarding function of the system every way you can imagine.

When you are certain of the complete security of the system, solder or weld all antenna joints. Test the antenna again.

Return to the Installation section (page 9) and follow the instructions for wiring the Stop and Warning Outputs.

Pre-Operation Checklist

- I have read and understand the Failsafe Design section (page *ix*).
- I have checked the design, construction and installation of the antenna for compliance with all requirements specified in the Antenna Design section (pages 2-5).
- I have checked the installation of the control unit and the coupler for compliance with all requirements specified in the Installation section (pages 6-9).
- I have insured that the sensing field is clear of all personnel.
- I have either cleared the sensing field of barrels, containers and other movable objects or constructed grounded shields to minimize any influence they have on the sensing field. Ideally, two (2) bargraph segments of influence should be the maximum.
- I have visually examined the PC1000 Proxagard® control unit, wiring, coupler, coupler cable and antenna for any signs of damage, loose connections or other physical problems.

- I have insured that the antenna design and the chosen alarm point setting do not allow access to any pinch point, from any direction, without causing the Proxagard® system to alarm and the machine to stop.

If any of the preceding requirements are not met, do not allow machine operation until corrective action has been taken. If all requirements are met, proceed with the Operational Test.

Operational Test

This test is meant for existing systems that comply with all the design and installation requirements previously presented and must be performed **daily or any time there is a change of personnel, dies or operating environment.**

- Apply power to the system.

Condition 1 - System tunes and enters Run mode:

- Check the alarm operation of the Proxagard®, to insure that the unit alarms properly and causes machine-stop.
- Test the alarm point setting. To do this, reach toward each pinch point with an extended fingertip, to insure they are all guarded. Attempt to defeat the guarding function of the system every way you can imagine.
- Insure that the antenna and any shields do not move or vibrate.
- Operate the machine and observe the bargraph for any evidence of machine motion influence on the sensing field. Ideally, there should not be more than two (2) bargraph segments of influence on the field.

If the system does not comply with all of these requirements, do not allow operation of the machine.

Operation

Condition 2 - System powers-up with an Antenna Fault alarm:

- Push the Reset keypad - **1**.
- If the unit resets and enters Run mode, perform all the steps for **Condition 1**.
- If the unit fails to reset, perform all the steps for **Condition 3** and, then, perform the steps for either **Condition 4** or **Condition 5**, depending on the results.

Condition 3 - System fails to tune:

- Perform the first six (6) steps of the Pre-Operation Checklist (page 14) and take any required corrective action.
- Enter the tune code - **3232**.

Condition 4 - System still fails to tune:

- Turn to Appendix D (page 19) for troubleshooting procedures and technical support information.

Condition 5 - System now tunes properly and enters Run mode:

- Perform the Set Alarm Procedure. Enter the function code - **3233** then, **3** to set the alarm point.
- If desired, perform the Set Warning Procedure. Enter the function code - **3213** then, **3** to set the warning alarm point.
- Perform all the steps for **Condition 1**.

Appendix A

Quick-Check Procedure

This procedure is meant to provide the new user with a means to become familiar with Proxagard® operation - on the bench, in a non-safety environment. It may also be useful to an experienced user, as a troubleshooting aid.

❑ Make a test antenna. We recommend a section of copper tubing three to ten feet (one to three meters) long.

❑ Use the screws provided with the unit to fasten the coupler to the test antenna. You must sand the area of the tubing where the coupler contact plate meets the tubing, to expose bare, clean metal and insure good electrical contact.

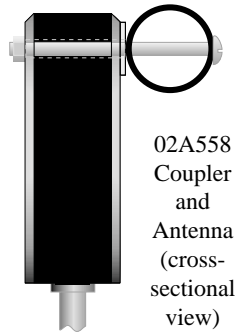

❑ Place the test antenna on two cardboard cartons or other insulators that can provide a minimum of twenty-eight inches (71.1 cm) of clearance from surrounding objects.

❑ Follow the control unit and power wiring instructions on pages 7 and 8, but wire the unit to power and ground on the test bench instead of a machine control circuit.

❑ Press **3232** to tune, and stand clear.

❑ When the alarm light goes out, test the sensitivity. To do this, reach toward the antenna with an extended hand. The unit should alarm at a nominal distance of twenty-eight inches (71.1 cm), with the Hi-Lo switch in Hi position or fourteen inches (35.6 cm), with the Hi-Lo switch in Lo position.

❑ Perform the Set Alarm Procedure. Enter the function code - **3233** then, reach toward the antenna with an extended hand until the first ten bargraph segments are lit. Press **3**, to set the alarm point.

❑ Test the alarm point setting, as above. The unit should alarm at a nominal distance of five inches (12.7 cm), with the Hi-Lo switch in the Hi position or half an inch (1.27 cm), with the Hi-Lo switch in Lo position.

❑ Shield a portion of the test antenna (see the Antenna Design section on pages 2-5). Note the changes in field shape and strength.

Sensitivity vs. Load

The gray area represents the range of effective field sizes that can be achieved around an unshielded antenna element of a specified length, with the 02A558 Coupler set in the Hi position.

This graph is presented as an approximation, and assumes an antenna element with a minimum distance of four inches (10.2 cm) from ground.

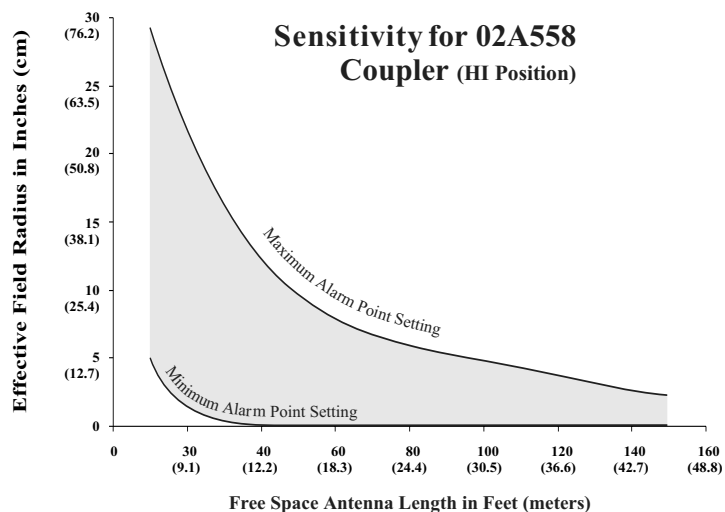

Antenna Length and Effective Field Size

It is often helpful, when designing an antenna, to form an approximation of the overall length of antenna and the average distance of the elements from ground. This information, along with the graphs at the bottom of the page, will help you to determine the effective field radius around an individual element, at a given coupler and alarm point setting. The effective field radius gives the designer a guideline to determine the maximum allowable spacing between parallel elements.

Example

For example, a single antenna element thirty feet (9.1 m) long, with an average distance from ground of six inches (15.2 cm), the coupler set to the Hi position and the alarm point defaulted to maximum will have an approximate effective field radius of twenty-three inches (58.4 cm). With the coupler set to the Lo position, the effective field radius is reduced to eleven inches (27.9 cm).

Coaxial Cable and Loading

It is sometimes desirable to connect two sections of antenna element with a piece of RG62/U coaxial cable. In these cases, the center conductor should be connected to the antenna element and the braided shield should be grounded - the result is a connecting cable that is insensitive and has a

load equivalence of 2.7 feet (82.3 cm) of antenna for every foot (30.5 cm) of cable.

As a comparison to the previous example, take two elements, one fifteen feet and the other fourteen feet, and connect them with one foot of RG62/U coaxial cable. The elements themselves have a combined length of twenty-nine feet, but the one foot of coaxial cable is equivalent to 2.7 feet of antenna. The result is an apparent load of 31.7 feet, not thirty feet, and an effective field radius closer to twenty-one inches than twenty-three in the Hi position.

Parallel Elements and Field Reinforcement

Typically, you can expect a ten percent field reinforcement between parallel antenna elements and as much as twenty-five percent reinforcement with rectangular antenna configurations.

Note

The information in this appendix is meant to provide the antenna designer with the means to approximate a basic antenna configuration. All antenna designs require fine tuning and thorough testing. Whenever you design or alter an antenna, carefully follow the instructions in the Antenna Design, Installation and Operation sections.

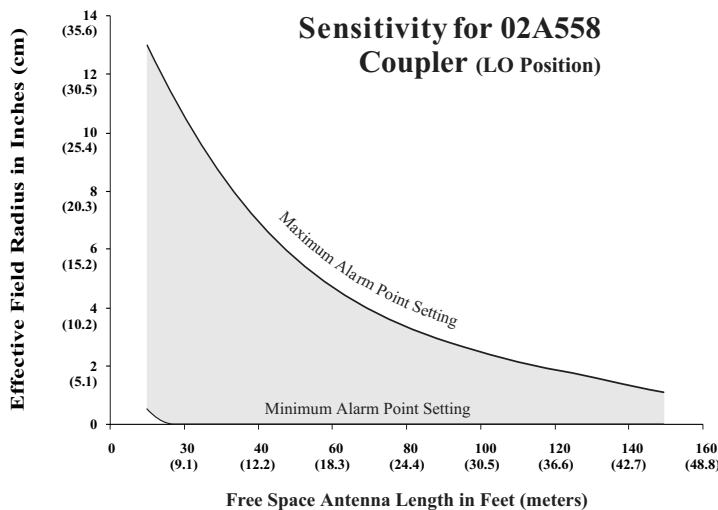

Sensitivity vs. Load

The gray area represents the range of effective field sizes that can be achieved around an unshielded antenna element of a specified length, with the 02A558 Coupler set in the Lo position.

This graph is presented as an approximation, and assumes an antenna element with a minimum distance of four inches (10.2 cm) from ground.

Appendix C

Planar Field Antenna

The concepts associated with planar field antenna design (reinforcing fields and grounded shields, specifically) are introduced in the Antenna Design section (pages 2-5). We recommend that you familiarize yourself with these concepts before you attempt to construct your planar field antenna.

Antenna Construction

The antenna should be rectangular in shape and may be constructed of 1/2" or 3/4" tubing or 1/2" flat stock - copper, steel or aluminum are the preferred materials, but any rigid conductor is usable.

Cut the material to the desired lengths and either weld the corners or solder them together with copper elbow fittings. The maximum length for the narrower dimension is limited to thirty-six inches (91.4 cm).

Insulator Construction

Use the illustration at the bottom of the page as a guideline for making your insulators. They should be made from PVC or nylon bar stock that is one inch (2.54 cm) in diameter. They should be two inches (5.08 cm) in length, with holes top and bottom- tapped for 5/16" (8 mm) screws. The bottoms of the tapped holes must be at least one inch (2.54 cm) apart.

Antenna/Insulator Assembly

Drill clearance holes through the antenna, in the configuration shown in the illustration below, and fasten the insulators to the antenna with the appropriate length screws and lockwashers. A minimum of eight insulators must be used, but the number and the span between insulators will vary with the materials used for the antenna element - rigidity is the controlling factor.

Grounded Shield Construction

The grounded shield should be constructed of two inch (5.08 cm) wide and eighth inch (.32 cm) thick steel or aluminum flat stock.

Measure the width of the antenna/insulator assembly to the outside edges of the insulators and cut two pieces of the shield material to this length. Then, make a measurement of the height and add two times the thickness of the shield material to the measurement. Now, cut two pieces of the shield material to this length. Weld the corners of the shield sections - corner braces may be used for added strength.

Antenna/Shield Assembly

Place the shield around the antenna/insulator assembly to insure that it fits properly. Then, make measurements for mounting the shield to the insulators. Drill clearance holes through the shield and fasten the shield to the insulators with the proper length screws and lockwashers.

Planar Field Antenna

This illustration shows the basic components of a planar field antenna.

The insert provides dimensional information for the insulators and the grounded shield.

Please note, a rectangular antenna window's narrowest dimension has a maximum limit of thirty-six inches (91.4 cm).

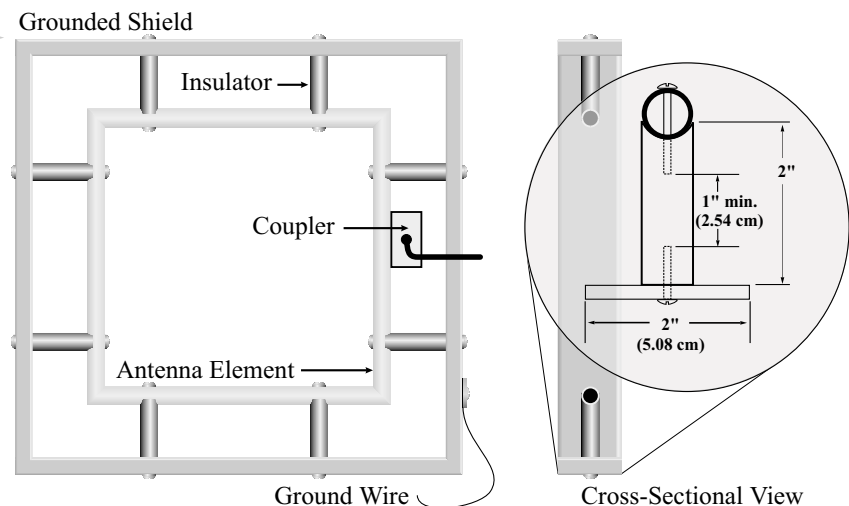

Antenna/Coupler Assembly

Drill clearance holes through the antenna (use the illustration below to determine the size and spacing of the holes) and fasten the coupler to the antenna with the hardware provided with the unit. You must sand the area of the tubing where the coupler contact plate meets it, to expose bare, clean metal and insure good electrical contact. Dress the coupler cable so that it exits the coupler perpendicular to the antenna. The cable must not be routed along or attached to the antenna element.

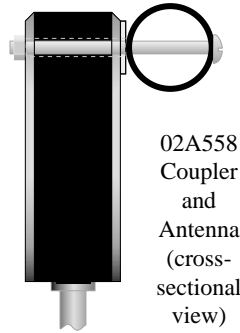

02A558 Coupler and Antenna (cross-sectional view)

Planar Field Antenna Installation

To determine the proper mounting distance for your antenna, as mandated by OSHA regulation, refer to the Antenna Design section (page 2).

Secure the Planar Field Antenna to the machine. The antenna must be firmly mounted and incapable of movement in any direction. **Machine parts or fixtures must not extend inward past the plane of the grounded shield,** as this can result in a reduction in field sensitivity.

Attach a copper ground wire to the shield and connect the other end to the machine control ground.

Now, return to the Installation section (pages 6-9) and follow the procedures to complete your installation. You must also complete all the test procedures in the Operation section (pages 10-15).

As a final word of caution, grounded shields may create a situation where a person can reach around the outside of the shield to a pinch point. If this is the case in your application, you must provide a means of guarding the accessible pinch points. In the types of applications where planar field antennas are employed, that usually means installation of fixed barrier guards.

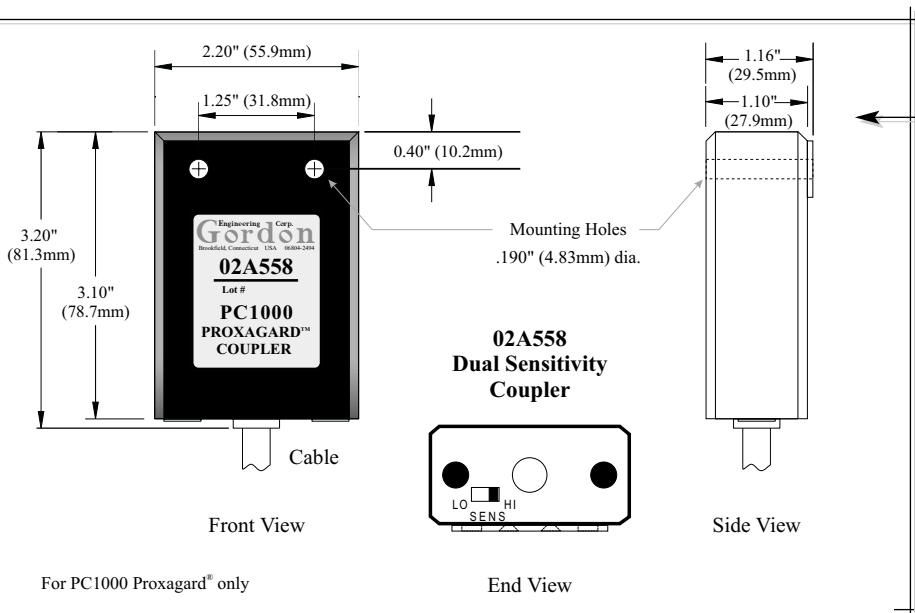

02A558 Coupler

This dimensional information is needed to determine the size and placement of coupler mounting holes on the antenna element of your planar field antenna.

Initially, the Hi-Lo Switch should be set to the Hi position. If the alarm point needs to be set to the ninth or tenth bargraph segment, switch to Lo and retune.

Appendix D

Troubleshooting

If the system goes into alarm and will not reset, there are some basic procedures to follow that will allow you to rectify the problem or direct you to contact tech support. If you follow these procedures, in most cases the problem can be resolved by you or by tech support, without removal of the unit.

Observe the Indicators

Observe the Function Indicators, Bargraph segments and Alarm Light and write down the status of each (on or off). At the bottom of page twenty-one there is an illustration of fault codes. If the bargraph displays any of these codes, note the number of the code rather than the status of each bargraph segment.

Verify Power and Ground

- Input line voltage is within ratings and Control Unit selector switch is in the proper position.
- Terminal 1 of the Control Unit (see the illustration on page eight) measures three Ohms or less to machine control ground.

Verify Antenna Integrity

- Antenna sections are not grounded, loose, making intermittent contact or missing.

Antenna Fault Condition

- The unit's Alarm Light, Run Indicator, Antenna Fault Indicator and a single Bargraph segment are lit.
- Press the Reset (1) keypad.** If the unit does not reset, refer to page thirteen for a detailed description on resetting an Antenna Fault alarm.

Incomplete Set Alarm Procedure

- The unit's Alarm Light, Set Alarm Indicator and a single Bargraph segment are lit.
- Press the Set (3) keypad.** The unit should come out of alarm, refer to page thirteen for a detailed description of the Set Alarm function.

Tuning Faults

- The unit's Alarm Light and Tune Indicator are lit and the Bargraph displays **Fault Code 1.**
- Enter the Tune function code - 3232.** Make sure no one is in the sensing field.
- The unit tunes successfully.** The problem may have been movement in the sensing field during the tuning procedure (an object or a person). Check all pinch points before you allow machine operation.

PC1000 Function Codes

This is a quick reference of function and reset codes - for detailed explanations of these functions, refer to the function's corresponding subsection.

The reset for a tuning fault is the Tune Function code - if the unit will not retune, there is an underlying problem.

Functions

Codes

| | | |
|--------------------|-------------|------------------------|
| Tune | 3232 | |
| Set Alarm | 3233 | then 3 (to set) |
| Set Warning | 3213 | then 3 (to set) |

Resets

| | |
|-------------------------|-------------|
| Antenna Fault | 1 |
| Self Check Fault | 3231 |

Appendix D

failures that may be caused by severe noise spikes or low line voltage. Non-catastrophic faults can be reset by the authorized user.

The unit does not tune successfully. Remove the coupler from the antenna and place it on an insulated surface. Enter the Tune function code - **3232**. If the unit tunes successfully, the problem is a fault in the antenna - it may be grounded or too large.

Rectify the antenna problem and reinstall the coupler. Attempt to tune the system. If the unit tunes successfully, check all pinch points before you allow machine operation. If the unit fails to tune, call tech support.

The unit's Alarm Light and Tune Indicator are lit and the Bargraph displays **Fault Code 2**. This fault is related to settings stored in memory and usually occurs on power-up.

Enter the Tune function code - 3232. Make sure no one is in the sensing field.

The unit tunes successfully. Check all pinch points before you allow machine operation.

The unit does not tune successfully. If the unit fails to tune, call tech support.

Enter the Self Check Reset code - 3231.

The unit resets successfully. Check all pinch points before you allow machine operation.

The unit does not reset successfully. Remove power from the unit for several seconds, return power and attempt to reset the unit, again.

The unit resets successfully. Check all pinch points before you allow machine operation.

The unit does not reset successfully. If the unit fails to reset, call tech support.

Self Check Faults

Self Check Faults are indicated by **Fault Codes three (3) through seven (7)**. These faults occur when a failure is detected by the control unit - some are catastrophic and others are functional

PC1000 Fault Codes

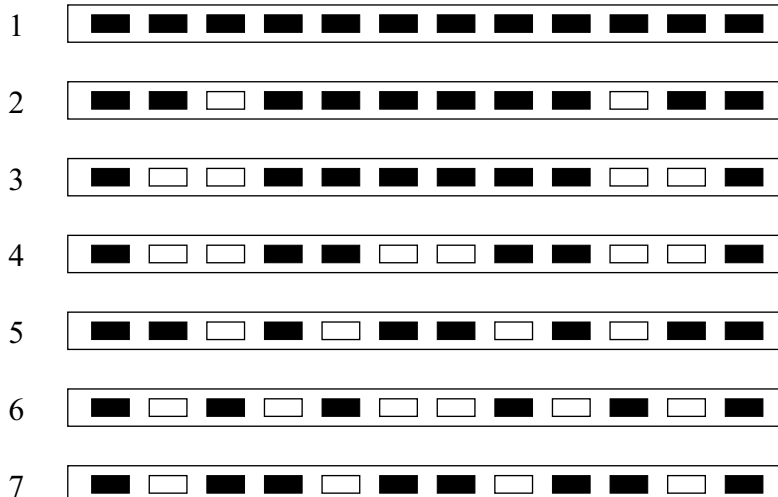

There are two categories of fault codes - Tuning Faults (bargraph patterns one and two) and Self Check Faults (bargraph patterns three through seven).

Be sure to note which of these codes is displayed, before you attempt to reset the unit. This information is necessary for tech support to analyze the problem, if it recurs or if you are unable to reset the unit yourself.

Gordon Engineering Corp. has a 25 year history of development and innovation in the areas of capacitive presence sensing and brake monitoring. Throughout that time we have been committed to providing our customers with the highest quality products and services available.

Our products have undergone several generational redesigns - as technology changed, we incorporated the benefits of that change into our products. These innovations allow us to offer our customers numerous product enhancements, while we maintain very competitive prices.

In addition to our standard line of safety products, Gordon supplies many OEMs with designs that are application-specific. Our ability to do this is facilitated by the fact that all our facilities, engineering and manufacturing, are located in the **United States of America.**

Our policy has always been to provide our customers with products that are reliable and well-engineered, at a price that delivers maximum value.

Just call or e-mail us to get application and engineering assistance, pricing and delivery. Evaluate our products, risk-free, on a **30-Day Free Trial** basis, and get a **Five-Year Warranty** when you decide to buy.

