

Air Cooled CO₂/MAG Welding Torch

BLUE TORCH III

OWNER'S MANUAL 『Parts List』

BT300D-30UT . . . 1U6334
 BT300D-45UT . . . 1U6335
 BT300D-60UT . . . 1U6336

BT300D-30UT

BT300D-45UT

BT300D-60UT

■ Rated Specification

Rated Current and Duty Cycle		300A 35%(CO ₂) / 250A 35%(MAG)		
Torch Length		3.0m/10ft	4.5m/15ft	6.0m/20ft
Net Weight		3.6kg/7.9lb	4.8kg/10.6lb	6.0kg/13.2lb
Diameter range of the electrode ※1	mm	(0.9) , (1.0) 1.2 , (1.4)	(1.0) , 1.2 (1.4)	1.2 , (1.4)
	inch	(.035) , (.040) .045 , (.052)	(.040) , .045 (.052)	.045 , (.052)
Type of the electrode		Mild steel wire , Flux-cored wire		
Type of shielding gas		CO ₂ , MAG		
Type of cooling		Air Cooled		
Method of guidance		Manual		
Voltage rating		113V(Peak)		
Torch switch technical data		DC30V 3A		

※1:“()”: Optional parts are necessary.

Standard Parts List

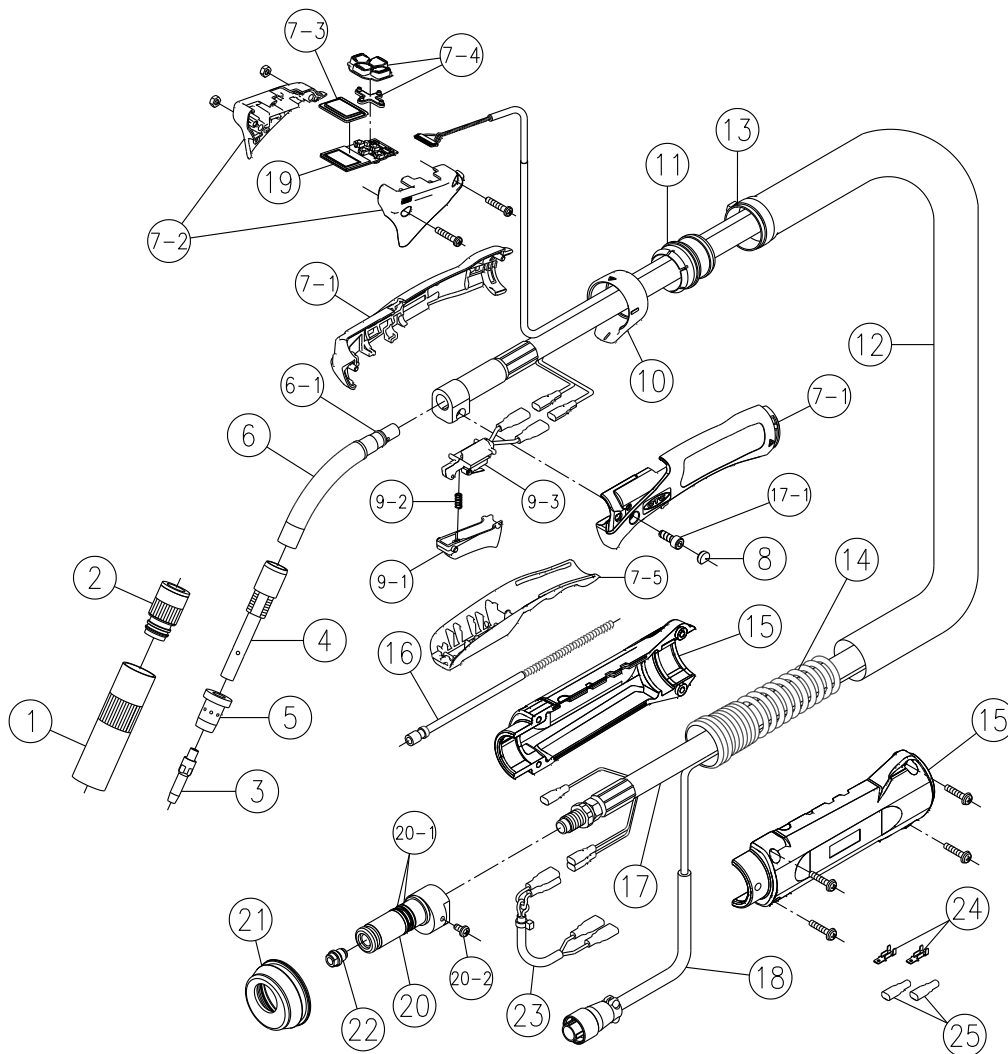



No.	Part Description	Part No.	No.	Part Description	Part No.
①	Nozzle (I.D.16mm)	U4167G01	⑬	Binder	4739-606
②	Insulator	U4167L00	⑭	Spring	U5626M04
③	Contact Tip (1.2mm/.045")	K980C26	⑮	Cable Support (with Screw)	U6205S00
④	Tip Body	U4167G03		Liner	
⑤	Orifice	U4167G02	⑯	3.0m/10ft (0.9~1.2mm/.035"~.045")	U4170H02
⑥	Torch Body (R77,55°)	U6196B00		4.5m/15ft (1.0~1.2mm/.040"~.045")	U6194L00
⑥-1	O-Ring (S9-4D)	3574-001		6.0m/20ft (1.2mm/.045")	U6195L00
⑦	Handle KIT (⑦-1~5 is included.)	U6280V00		Power Cable (with Screw)	
⑦-1	Handle (L/R)	U6256D00	⑰	3.0m/10ft	U6286D00
⑦-2	Handle (Upper L/R with Screw)	U6280X00		4.5m/15ft	U6287D00
⑦-3	Screen Cover	U6280H03		6.0m/20ft	U6288D00
⑦-4	Button (with Button Guide)	U6280Y00	⑰-1	Bolt with hole (M5X14)	100-0310
⑦-5	Handle (Lower)	U6196H04		Communication Cable	
⑧	Cap	U5341G01	⑱	3.0m/10ft	U6286U00
⑨	Trigger ASSY (⑨-1~3 is included.)	U6190T00	⑲	4.5m/15ft	U6287U00
⑨-1	Trigger	U6190T01		6.0m/20ft	U6288U00
⑨-2	Trigger Spring	U157E04	⑲	Control Board	K5961P00
⑨-3	Switch ASSY	U6190Q00	⑳	Power Fitting "NO.4" (with Screw)	U5972E00
⑩	Lock Ring	U6205H05	⑳-1	O-Ring (AS-014(4D))	100-0818
⑪	End Joint	U5626R01	⑳-2	Small Screw (M4X8)	100-0297
	Hose Sheath		㉑	Rubber Sleeve	U5972G01
⑫	3.0m/10ft	U6205R00	㉒	Wire Guide (0.9~1.2mm/.035"~.045")	U5972G02
	4.5m/15ft	U6287R00	㉓	Switch Cord	U5972F00
	6.0m/20ft	U6288R00	㉔	Terminal (LOM-21T-187)	100-0820
			㉕	Cap (253224)	100-0821

Optional Parts List



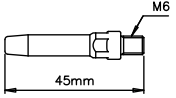
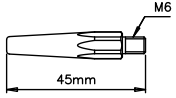
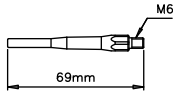
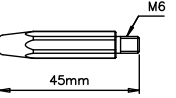
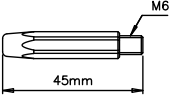

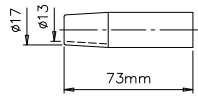
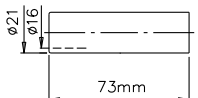
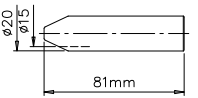
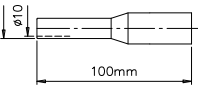
※The dimension of the drawing is a reference value.

UNIT (mm)

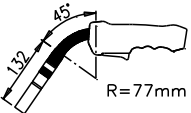
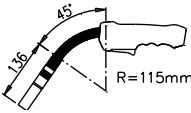
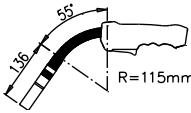
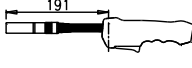
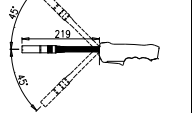
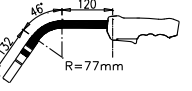
Contact Tip					
	A-Tip (Standard)	T-Tip (High Current)	Long Tip	CW-Tip (Long Life)	Heavy Current
Wire Size					
0.9mm (.035")	K980C24	K662B12	U4167H07	-	U4167H14
1.0mm (.040")	K980C25	K980C17	U4167H06	-	U4167H13
1.2mm (.045")	K980C26 K980C73 (For FCW)	K980C19	U4167H05	K990E12	U4167H12
1.4mm (.052")	K980C27 K980C74 (For FCW)	K980C20	-	K990E14	U4167H11

Nozzle				Heat Shield	
Low Current	High Current	Arc Spot	Deep and Narrow Space	Standard	For "Pistol Grip Handle"
U4167H01	U4167H16	U4170H01	U4167H04	U6256H00	U6256N00
			 Combine with Long Tip.		

Torch Body					
R77, 45°	R115, 45°	R115, 55°	Straight	Flexible	Long Neck
U5347B00	U5350B00	U6199B00	U5339H00	U5339L00	U5339N00
				 Inner liner is required.	

Modular Torch Handle/Trigger Options				(tool-less/quick-change style)
Extended Trigger	Slim Grip Handle	Trigger Guard Grip Handle	Pistol Grip Handle Kit	
U6256T00	U6256B01	U6256B02	U6256K00	Assembly
 Assembly	 Assembly	 Assembly		

Wire Guide	
Wire Size	Part No.
1.2~1.6mm .045"~1/16"	U5978G02

※1 "Extended Trigger" is not made in combination with "Trigger Guard Grip Handle" and "Pistol Grip Handle Kit".
 ※2 "Switch ASSY(U6190Q00)" and "Trigger Spring(U157E04)" are not included in "Extended Trigger".
 ※3 "Trigger ASSY(U6190T00)" is not included in "Slim Grip Handle" and "Trigger Guard Grip Handle".
 ※4 Please order "U6256M00" towards "Trigger ASSY(U6190T00)" is not required to "Pistol Grip Handle Kit".

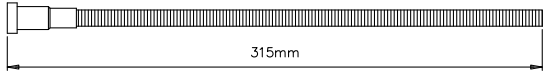
Inner Liner		
Wire Size	Part No.	These are available for the torch bodies above.
0.8~1.2mm/.030"~.045"	U5003L82	
1.2~1.6mm/.045"~1/16"	U5003L26	
		

Liner		
Wire Size	Length	Part No.
1.2~1.6mm/.045"~1/16"	3.0m/10ft	U6199L00
1.2~1.6mm/.045"~1/16"	4.5m/15ft	U6200L00
1.2~1.6mm/.045"~1/16"	6.0m/20ft	U6201L00

■ Voltage Detecting Cable
Part No. : U 5 3 6 5 P 0 0

※In order to use voltage detecting cable, you will need to modify the welding power source and wire feeder. For detail, see owner's manual of the welding power source and wire feeder.

■ Intelligent torch combined equipment

Wire Feeder : CM - 7 4 3 - U
+ Intelligent panel kit(K5952G00)
+ LCD panel (E-2627) or digital panel(E-2628)

Welding Power Source : CO2/MAG Welbee series

Torch Type

BT 300D-30UT

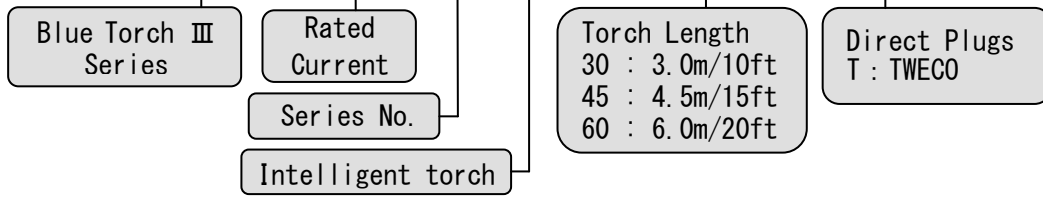

Electrical connection diagram

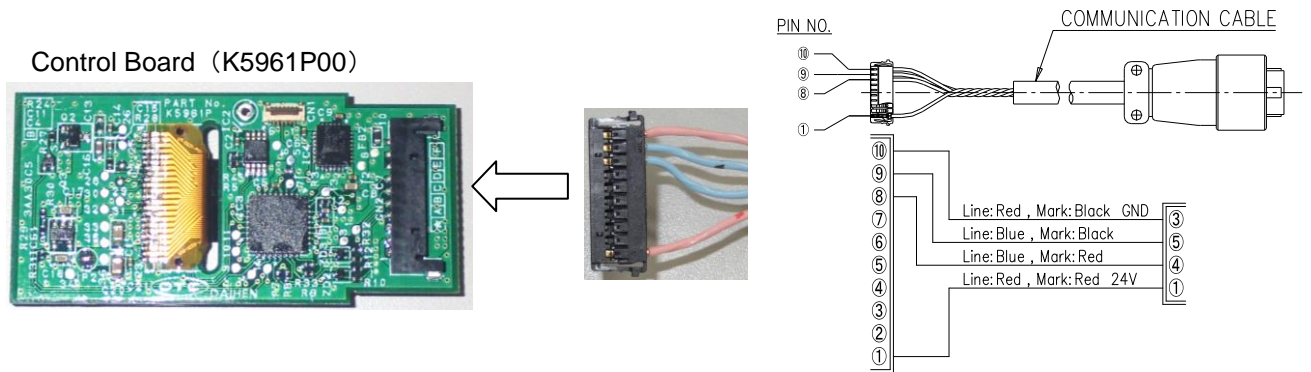

Dimensional Outline Drawing

