

Datasheet - IFL 3B-8M-10P

Inductive proximity switch / Housing construction form: cylinder, thread / IFL - M8



Preferred typ



(Minor differences between the printed image and the original product may exist!)

- Design M 8 x 1
- Metal enclosure
- DC 3-wire
- miniature body
- higher switching distance

Ordering details

Product type description	IFL 3B-8M-10P
Article number	101110822
EAN Code	4030661020730
eCl@ss	27-27-01-01

Global Properties

Permanent light	IFL - M8
Standards	IEC/EN 60947-5-2; DIN VDE 0660-208
Compliance with the Directives (Y/N) 	Yes
Operating resource protection class	None
Materials	
- Material of the housings	Brass
- Material of the nuts	Brass
- Material of the cable mantle	PVC
- Material of the active surface	Plastic
Housing coating	nickel-plated
Housing construction form	cylinder, thread
Weight	55

Mechanical data

Design of electrical connection	Cable
Cable length	2
Conductor with strain relief	No
Conductors	3 x 0,14
mechanical installation conditions	Quasi-embeddable
Switch distance S_n	3 mm
Reduction factor 1 met (Y/N)	No
Protection circuit	inductive interference protection, Protection against polarity reversal, short-circuit and overload proof
Pressure resistant (Y/N)	No
Tightening torque for nuts	A/F 13 max. 600 Ncm

Ambient conditions

Ambient temperature	
- Min. environmental temperature	-10
- Max. environmental temperature	+70
Protection class	IP67 to IEC/EN 60529

Electrical data

Design of control element	Normally open contact (NO)
Number of wire	3
Voltage type	DC, direct current
Supply voltage U_B	
- Min. supply voltage	10
- Max. supply voltage	30
Switch frequency	approx. 1500 HZ
Voltage drop U_d	approx. 1.2 V (200 mA)
Operating current I_e	200 mA
No-load current I_0	approx. 1.7 mA (10 V), approx. 4 mA (24 V), approx. 5 mA (30 V)

Outputs

Design of control output	PNP
--------------------------	-----

LED switching conditions display

LED switching conditions display (Y/N)	Yes
- yellow LED	

ATEX

Explosion protection categories for gases	None
Explosion protected category for dusts	None

Dimensions

Dimensions of the sensor	
- Length of sensor	42
- Diameter of sensor	M8

Indication legend



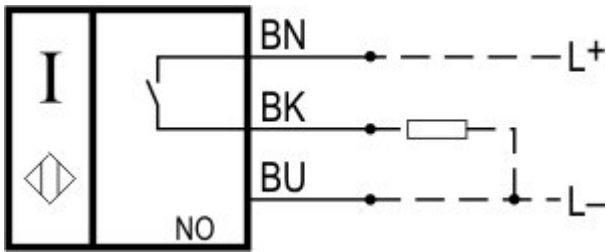

May not be charged in this area!

x = 0,6 mm

Diagram



Note Diagram

-  positive break NC contact
-  active
-  no active
-  Normally-open contact
-  Normally-closed contact

Ordering code

IFL (1)-(2)(3)-(4)(5)(6)(7)

(1)	
2	Switch distance 2 mm
3	Switch distance 3 mm
B	Quasi-embeddable
(2)	
8	cylinder, thread M8
(3)	
without	Included in standard version Design
M	miniature body
(4)	
01	Opener (NC)
10	Normally open contact (NO)
10/01	Normally open contact (NO) / Opener (NC) with Wiring compartment
11	Normally open contact (NO) / Opener (NC) antivalent
(5)	
without	Cable
ST	Connector
(6)	
without	Included in standard version Plug-in connection
2	Alternative Plug-in connection
(7)	
N	n-type
P	p-type

Documents

Operating instructions (nl) 134 kB, 01.08.2018

Code: mrl_ifl-allgemein_nl

Operating instructions (en) 128 kB, 31.08.2016

Code: mrl_ifl-allgemein_en

Operating instructions (pl) 137 kB, 21.10.2016

Code: mrl_ifl-allgemein_pl

Operating instructions (pt) 109 kB, 06.04.2017

Code: mrl_ifl-allgemein_pt

Operating instructions (it) 108 kB, 21.10.2016

Code: mrl_ifl-allgemein_it

Operating instructions (es) 110 kB, 21.10.2016

Code: mrl_ifl-allgemein_es

Operating instructions (cn) 177 kB, 05.05.2017

Code: mrl_ifl-allgemein_cn

Operating instructions (de) 131 kB, 31.08.2016

Code: mrl_ifl-allgemein_de

Operating instructions (fr) 110 kB, 21.10.2016

Code: mrl_ifl-allgemein_fr

Declaration of conformity (en) 91 kB, 13.04.2017

Code: konfi_ifl_en

Declaration of conformity (de) 96 kB, 01.07.2016

Code: konfi_ifl_de

Images

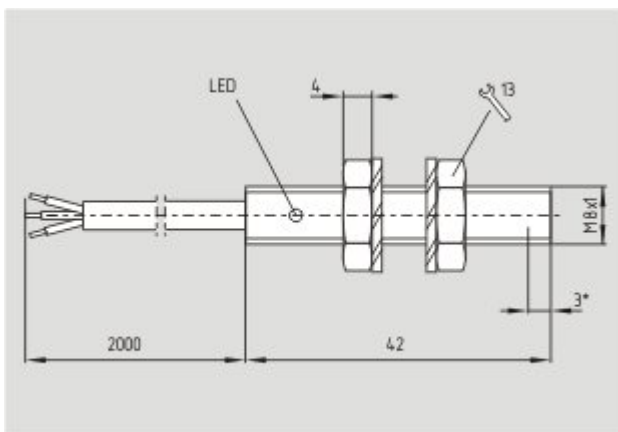

Dimensional drawing (basic component)

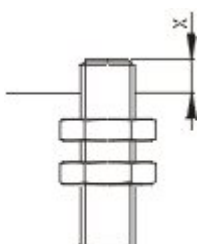

Operating principle

K.A. Schmersal GmbH & Co. KG, Möddinghofe 30, D-42279 Wuppertal

The data and values have been checked thoroughly. Technical modifications and errors excepted.

Generiert am 29.08.2018 - 15:36:55h Kasbase 3.3.0.F.64I